

Contents

| | | |
|-----------|--|-----------|
| V | FLUID MECHANICS | ii |
| 13 | Foundations of Fluid Dynamics | 1 |
| 13.1 | Overview | 1 |
| 13.2 | The Macroscopic Nature of a Fluid: Density, Pressure, Flow Velocity; Liquids vs. Gases | 3 |
| 13.3 | Hydrostatics | 7 |
| 13.3.1 | Archimedes' Law | 8 |
| 13.3.2 | Nonrotating Stars and Planets | 9 |
| 13.3.3 | Hydrostatics of Rotating Fluids | 11 |
| 13.4 | Conservation Laws | 16 |
| 13.5 | The Dynamics of an Ideal Fluid | 20 |
| 13.5.1 | Mass Conservation | 20 |
| 13.5.2 | Momentum Conservation | 21 |
| 13.5.3 | Euler Equation | 21 |
| 13.5.4 | Bernoulli's Theorem | 22 |
| 13.5.5 | Conservation of Energy | 26 |
| 13.5.6 | Joule-Kelvin Method of Cooling a Real Gas | 30 |
| 13.6 | Incompressible Flows | 31 |
| 13.7 | Viscous Flows with Heat Conduction | 34 |
| 13.7.1 | Decomposition of the Velocity Gradient | 34 |
| 13.7.2 | Navier-Stokes Equation | 35 |
| 13.7.3 | Energy conservation and entropy production | 36 |
| 13.7.4 | Molecular Origin of Viscosity | 38 |
| 13.7.5 | Reynolds' Number | 38 |
| 13.7.6 | Pipe Flow | 39 |
| 13.8 | T2 Relativistic Dynamics of an Ideal Fluid | 41 |
| 13.8.1 | T2 Stress-Energy Tensor and Equations of Relativistic Fluid Mechanics | 41 |
| 13.8.2 | T2 Relativistic Bernoulli Equation and Ultrarelativistic Astrophysical Jets | 42 |
| 13.8.3 | T2 Nonrelativistic Limit of the Stress-Energy Tensor | 44 |

Part V
FLUID MECHANICS

Fluid Mechanics

Version 1113.2.K, 26 January 2012. [This supersedes version 1113.1.K, which was passed out to Yanbei Chen's class]

Please send comments, suggestions, and errata via email to kip@caltech.edu or on paper to Kip Thorne, 350-17 Caltech, Pasadena CA 91125

Having studied elasticity theory, we now turn to a second branch of continuum mechanics: *fluid dynamics*. Three of the four states of matter (gases, liquids and plasmas) can be regarded as fluids, so it is not surprising that interesting fluid phenomena surround us in our everyday lives. Fluid dynamics is an experimental discipline and much of our current understanding has come in response to laboratory investigations. Fluid dynamics finds experimental application in engineering, physics, biophysics, chemistry and many other fields. The observational sciences of oceanography, meteorology, astrophysics and geophysics, in which experiments are less frequently performed, are also heavily reliant on fluid dynamics. Many of these fields have enhanced our appreciation of fluid dynamics by presenting flows under conditions that are inaccessible to laboratory study.

Despite this rich diversity, the fundamental principles are common to all of these applications. The key assumption which underlies the governing equations that describe the motion of a fluid is that the length and time scales associated with the flow are long compared with the corresponding microscopic scales, so the continuum approximation can be invoked.

The fundamental equations of fluid dynamics are, in some respects, simpler than the corresponding laws of elastodynamics. However, as with particle dynamics, simplicity of the equations does not imply that the solutions are simple, and indeed they are not! One reason is that there is no restriction that fluid displacements be small (by contrast with elastodynamics where the elastic limit keeps them small), so most fluid phenomena are immediately nonlinear.

Relatively few problems in fluid dynamics admit complete, closed-form, analytic solutions, so progress in describing fluid flows has usually come from the introduction of clever physical “models” and the use of judicious mathematical approximations. In more recent years, numerical fluid dynamics has come of age and in many areas of fluid mechanics, computer simulations have begun to complement laboratory experiments and measurements.

Fluid dynamics is a subject where considerable insight accrues from being able to visualize the flow. This is true of fluid experiments, where much technical skill is devoted to marking the fluid so it can be photographed; it is also true of numerical simulations, where frequently more time is devoted to computer graphics than to solving the underlying partial differential

equations. We shall pay some attention to flow visualization. The reader should be warned that obtaining an analytic solution to the equations of fluid dynamics is not the same as understanding the flow; it is usually a good idea to sketch the flow pattern at the very least, as a tool for understanding.

We shall present the fundamental concepts of fluid dynamics in Chap. 13, focusing particularly on the underlying physical principles and the conservation laws for mass, momentum and energy. We shall explain why, when flow velocities are very subsonic, a fluid's density changes very little, i.e. it is effectively *incompressible*; and we shall specialize the fundamental principles and equations to incompressible flows.

Vorticity plays major roles in fluid dynamics. In Chap. 14 we shall focus on those roles (for incompressible flows), both in the fundamental equations of fluid dynamics, and in applications. Our applications will include, among others, tornados and whirlpools, boundary layers abutting solid bodies, the influence of boundary layers on bulk flows, and how wind drives ocean waves and is ultimately responsible for deep ocean currents.

Viscosity has a remarkably strong influence on fluid flows, even when the viscosity is very weak. When strong, it keeps a flow laminar (smooth); when weak, it controls details of the *turbulence* that pervades the bulk flow (the flow away from boundary layers). In Chap. 15 we shall describe turbulence, a phenomenon so difficult to handle theoretically that semi-quantitative ideas and techniques pervade its theoretical description. The onset of turbulence is especially intriguing; we shall illuminate it by exploring a closely related phenomenon: chaotic behavior in mathematical maps.

In Chap. 16, we shall focus on *waves* in fluids, beginning with waves on the surface of water, where we shall see, for shallow water, how nonlinear effects and dispersion together give rise to “solitary waves” (solitons) that hold themselves together as they propagate. We shall also explore, for the first time in Part V, the influence of compressibility, i.e. volume changes, initially in sound waves (where we shall meet radiation reaction), and then in a non-wave phenomenon: *convection*. Convection will also give us an opportunity to explore the (usually small but sometimes large) influence of diffusive heat conduction on fluid flows, and the influence of the diffusion of chemical constituents, e.g. salt.

In Chap. 17, we turn to transonic and supersonic flows, in which density changes are of major importance. Here we shall meet some beautiful and powerful mathematical tools: *characteristics* and their associated *Riemann invariants*. We shall focus especially on flow through rocket nozzles and other constrictions, and on shock fronts, with applications to explosions (bombs and supernovae).

When a fluid is electrically conducting and has an embedded magnetic field, the exchange of momentum between the field and the fluid can produce remarkable phenomena (e.g., dynamos that amplify a seed magnetic field, a multitude of instabilities, Alfvén waves and other magnetosonic waves). This is the realm of *magnetohydrodynamics*, which we explore in Chap. 18. The most common venue for magnetohydrodynamics is a highly ionized plasma, the topic of Part VI of this book; so Chap 18 serves as a transition from fluid mechanics (this Part V) to plasma physics (the next Part VI).

Chapter 13

Foundations of Fluid Dynamics

Version 1113.2.K, 26 January 2012 [This supersedes version 1113.1.K, which was passed out to Yanbei Chen's class]

Please send comments, suggestions, and errata via email to kip@caltech.edu or on paper to Kip Thorne, 350-17 Caltech, Pasadena CA 91125

Box 13.1 Reader's Guide

- This chapter relies heavily on the geometric view of Newtonian physics (including vector and tensor analysis) laid out in the Chap. 1.
- This chapter also relies on the concepts of strain and its irreducible tensorial parts (the expansion, shear and rotation) introduced in Chap. 11.
- Our brief introduction to relativistic fluid dynamics (track 2 of this chapter) relies heavily on the geometric viewpoint on special relativity developed in Chap. 2.
- Chapters 14–18 (fluid mechanics and magnetohydrodynamics) are extensions of this chapter; to understand them, the track-one parts of this chapter must be mastered.
- Portions of Part VI, Plasma Physics (especially Chap. 20 on the “two-fluid formalism”), rely heavily on track-one parts of this chapter.
- Portions of Part VII, General Relativity, will entail relativistic fluids in curved spacetime, for which the track-two Sec 13.8 of this chapter will be a foundation.

13.1 Overview

In this chapter, we develop the fundamental concepts and equations of fluid dynamics, first in the flat-space venue of Newtonian physics (track one), and then in the Minkowski spacetime

venue of special relativity (track two). Our relativistic treatment will be rather brief. This chapter contains a large amount of terminology that may be unfamiliar to readers. A glossary of this terminology is given in Box 13.5, near the end of the chapter.

We shall begin in Sec. 13.2 with a discussion of the physical nature of a fluid: the possibility to describe it by a piecewise continuous density, velocity, and pressure, and the relationship between density changes and pressure changes. Then in Sec. 13.3 we shall discuss hydrostatics (density and pressure distributions of a static fluid in a static gravitational field); this will parallel our discussion of elastostatics in Chap. 11. Following a discussion of atmospheres, stars and planets, we shall explain the physical basis of Archimedes' law.

Our foundation for moving from hydrostatics to hydrodynamics will be conservation laws for mass, momentum and energy. To facilitate that transition, in Sec. 13.4 we shall examine in some depth the physical and mathematical origins of these conservation laws in Newtonian physics.

The stress tensor associated with most fluids can be decomposed into an isotropic pressure and a viscous term linear in the rate of shear, i.e. in the velocity gradient. Under many conditions the viscous stress can be neglected over most of the flow, and diffusive heat conductivity is negligible. The fluid is then called *ideal*.¹ We shall study the laws governing ideal fluids in Sec. 13.5. After deriving the relevant conservation laws and equation of motion (the Euler equation), we shall derive and discuss the Bernoulli theorem for an ideal fluid and discuss how it can simplify the description of many flows. In flows for which the speed neither approaches the speed of sound, and gravity is too weak to compress the fluid much, the fractional changes in fluid density are small. It can then be a good approximation to treat the fluid as *incompressible* and this leads to considerable simplification, which we also study in Sec. 13.5. As we shall see, incompressibility can be a good approximation not just for liquids which tend to have large bulk moduli, but also, more surprisingly, for gases.

In Sec. 13.7 we augment our basic equations with terms describing viscous stresses. This allows us to derive the famous Navier-Stokes equation and illustrate its use by analyzing the flow of a fluid through a pipe, e.g. blood through a blood vessel. Much of our study of fluids in future chapters will focus on this Navier-Stokes equation.

In our study of fluids, we shall often deal with the influence of a uniform gravitational field, such as the earth's on lengthscales small compared to the earth's radius. Occasionally, however, we shall consider inhomogeneous gravitational fields produced by the fluid whose motion we study. For such situations it is useful to introduce gravitational contributions to the stress tensor and energy density and flux. We present and discuss these in a box, Box 13.4, where they will not impede the flow of the main stream of ideas.

We conclude this chapter in Sec. 13.8 with a brief overview of relativistic fluid mechanics for a perfect fluid (one with no viscosity or heat conduction). As an important application, we explore the structure of a relativistic astrophysical jet: the conversion of internal thermal energy into energy of organized bulk flow as the jet travels outward from the nucleus of a galaxy into intergalactic space, and widens. We also explore how the fundamental equations of Newtonian fluid mechanics arise as low-velocity limits of the relativistic equations.

¹An *ideal fluid* (also called a *perfect fluid*) should not to be confused with an *ideal or perfect gas*—one whose pressure is due solely to kinetic motions of particles and thus is given by $P = nk_B T$, with n the particle number density, k_B Boltzmann's constant, and T temperature; see Box 13.2.

13.2 The Macroscopic Nature of a Fluid: Density, Pressure, Flow Velocity; Liquids vs. Gases

The macroscopic nature of a fluid follows from two simple observations.

The first is that in most flows the macroscopic continuum approximation is valid: Because, in a fluid, the molecular mean free paths are small compared to macroscopic length-scales, we can define a mean local velocity $\mathbf{v}(\mathbf{x}, t)$ of the fluid's molecules, which varies smoothly both spatially and temporally; we call this the fluid's velocity. For the same reason, other quantities that characterize the fluid, e.g. the density $\rho(\mathbf{x}, t)$, also vary smoothly on macroscopic scales. Now, this need not be the case everywhere in the flow. The exception is a shock front, which we shall study in Chap. 17; there the flow varies rapidly, over a length of order the molecules' mean free path for collisions. In this case, the continuum approximation is only piecewise valid and we must perform a matching at the shock front. One might think that a second exception is a turbulent flow where, it might be thought, the average molecular velocity will vary rapidly on whatever length scale we choose to study, all the way down to intermolecular distances, so averaging becomes problematic. As we shall see in Chap. 15, this is not the case; in turbulent flows there is generally a length scale far larger than intermolecular distances below which the flow varies smoothly.

The second observation is that fluids do not oppose a steady shear strain. This is easy to understand on microscopic grounds as there is no lattice to deform and the molecular velocity distribution remains isotropic in the presence of a static shear. By kinetic theory considerations (Chap. 3), we therefore expect that a fluid's stress tensor \mathbf{T} will be isotropic in the local rest frame of the fluid (i.e., in a frame where $\mathbf{v} = 0$). This is not quite true when the shear is time varying, because of viscosity. However, we shall neglect viscosity as well as diffusive heat flow until Sec. 13.7; i.e., we shall restrict ourselves to ideal fluids. This allows us to write $\mathbf{T} = P\mathbf{g}$ in the local rest frame, where P is the fluid's pressure and \mathbf{g} is the metric (with Kronecker delta components, $g_{ij} = \delta_{ij}$).

The laws of fluid mechanics, as we shall develop them, are valid equally well for liquids, gases, and (under many circumstances) plasmas. In a liquid, as in a solid, the molecules are packed side by side (but can slide over each other easily). In a gas or plasma the molecules are separated by distances large compared to their sizes. This difference leads to different behaviors under compression:

For a liquid, e.g. the water in a lake, the molecules resist strongly even a very small compression; and, as a result, it is useful to characterize the pressure increase by a bulk modulus K , as in an elastic solid (Chap. 11):

$$\boxed{\delta P = -K\Theta = K\frac{\delta\rho}{\rho} \quad \text{for a liquid}} . \quad (13.1)$$

(Here we have used the fact that the expansion Θ is the fractional increase in volume, or equivalently by mass conservation the fractional decrease in density.) The bulk modulus for water is about 2.2 GPa, so as one goes downward in a lake far enough to double the pressure from one atmosphere (10^5 Pa to 2×10^5 Pa), the fractional change in density is only $\delta\rho/\rho = (2 \times 10^5/2.2 \times 10^9) \simeq$ one part in 10,000.

Box 13.2

Thermodynamic Considerations

One feature of fluid dynamics, especially gas dynamics, that distinguishes it from elastodynamics, is that the thermodynamic properties of the fluid are often very important, so we must treat energy conservation explicitly. In this box we review, from Chap. 5, some of the thermodynamic concepts we shall need in our study of fluids; see also, e.g., Reif (1959). We shall have no need for partition functions, ensembles and other statistical aspects of thermodynamics. Instead, we shall only need elementary thermodynamics.

We begin with the nonrelativistic first law of thermodynamics (5.8) for a sample of fluid with energy E , entropy S , volume V , number N_I of molecules of species I , temperature T , pressure P , and chemical potential μ_I for species I :

$$dE = TdS - PdV + \sum_I \mu_I dN_I. \quad (1)$$

Almost everywhere in our treatment of fluid dynamics (and throughout this chapter), we shall *assume that the term* $\sum_I \mu_I dN_I$ *vanishes*. Physically this happens because all relevant *nuclear* reactions are frozen (occur on timescales τ_{react} far longer than the dynamical timescales τ_{dyn} of interest to us), so $dN_I = 0$; and each *chemical* reaction is either frozen $dN_I = 0$, or goes so rapidly ($\tau_{\text{react}} \ll \tau_{\text{dyn}}$) that it and its inverse are in local thermodynamic equilibrium (LTE): $\sum_I \mu_I dN_I = 0$ for those species involved in the reactions. In the very rare intermediate situation, where some relevant reaction has $\tau_{\text{react}} \sim \tau_{\text{dyn}}$, we would have to carefully keep track of the relative abundances of the chemical or nuclear species and their chemical potentials.

Consider a small fluid element with mass Δm , energy per unit mass u , entropy per unit mass s , and volume per unit mass $1/\rho$. Then inserting $E = u\Delta m$, $S = s\Delta m$ and $V = \Delta m/\rho$ into the first law $dE = TdS - PdV$, we obtain the form of the first law that we shall use in almost all of our fluid dynamics studies:

$$\boxed{du = Tds - Pd\left(\frac{1}{\rho}\right)}. \quad (2)$$

The internal energy (per unit mass) u comprises the random translational energy of the molecules that make up the fluid, together with the energy associated with their internal degrees of freedom (rotation, vibration etc.) and with their intermolecular forces. The term Tds represents some amount of heat (per unit mass) that may get injected into a fluid element, e.g. by viscous heating (last section of this chapter), or may get removed, e.g. by radiative cooling. The term $-Pd(1/\rho)$ represents work done on the fluid.

In fluid mechanics it is useful to introduce the enthalpy $H = E + PV$ of a fluid element (cf. Ex. 5.5) and the corresponding enthalpy per unit mass $h = u + P/\rho$. Inserting $u = h - P/\rho$ into the left side of the first law (2), we obtain the first law in the “enthalpy representation” [Eq. (5.68)]:

Box 13.2, Continued

$$\boxed{dh = T ds + \frac{dP}{\rho}}. \quad (3)$$

Because all reactions are frozen or are in LTE, the relative abundances of the various nuclear and chemical species are fully determined by a fluid element's density ρ and temperature T (or by any two other variables in the set ρ , T , s , and P). Correspondingly, the thermodynamic state of a fluid element is completely determined by any two of these variables. In order to calculate all features of that state from two variables, we must know the relevant *equations of state*, such as $P(\rho, T)$ and $s(\rho, T)$; or $P = P(\rho, s)$ and $T = T(\rho, s)$; or the fluid's fundamental thermodynamic potential (Table 5.1) from which follow the equations of state.

We shall often deal with *perfect gases* (also called *ideal gasses*: gases in which intermolecular forces and the volume occupied by the molecules are treated as totally negligible). For any ideal gas, the pressure arises solely from the kinetic motions of the molecules and so the equation of state $P(\rho, T)$ is

$$\boxed{P = \frac{\rho k_B T}{\mu m_p}}. \quad (4)$$

Here μ is the *mean molecular weight* and m_p is the proton mass [cf. Eq. (3.37b), with the number density of particles n reexpressed as $\rho/\mu m_p$]. The mean molecular weight μ is the mean mass per gas molecule in units of the proton mass (e.g., $\mu = 1$ for hydrogen, $\mu = 32$ for oxygen O_2 , $\mu = 28.8$ for air); and this μ should not be confused with the chemical potential of species I , μ_I (which will rarely if ever be used in our fluid mechanics analyses). [The concept of an *ideal gas* must not be confused with an *ideal fluid* — one for which dissipative processes (viscosity and heat conductivity) are negligible.]

An idealisation that is often accurate in fluid dynamics is that the fluid is *adiabatic*; that is to say there is no heating or cooling resulting from dissipative processes, such as viscosity, thermal conductivity or the emission and absorption of radiation. When this is a good approximation, the entropy per unit mass s of a fluid element is constant following a volume element with the flow, i.e.

$$ds/dt = 0. \quad (5)$$

In an adiabatic flow, there is only one thermodynamic degree of freedom, so we can write $P = P(\rho, s) = P(\rho)$. Of course, this function will be different for fluid elements that have different s . In the case of an ideal gas, a standard thermodynamic argument (Ex. 5.4) shows that the pressure in an adiabatically expanding or contracting fluid element varies with density as $\delta P/P = \gamma \delta \rho/\rho$, where $\gamma = C_P/C_V$ is the adiabatic index

Box 13.2, Continued

[Eqs. (13.2) and (13.3)]. If, as is often the case, the adiabatic index remains constant over a number of doublings of the pressure and density, then we can integrate this to obtain the equation of state

$$\boxed{P = K(s)\rho^\gamma}, \quad (6)$$

where $K(s)$ is some function of the entropy. This is sometimes called the *polytropic* equation of state, and a *polytropic index* n (not to be confused with number density of particles!) is defined by $\gamma = 1 + 1/n$. See, e.g., the discussion of stars and planets in Sec. 13.3.2, and Ex. ???. A special case of adiabatic flow is *isentropic* flow. In this case, the entropy is constant everywhere, not just along individual streamlines.

Whenever the pressure can be regarded as a function of the density alone (the same function everywhere), the fluid is called *barotropic*.

Gases and plasmas, by contrast, are much less resistant to compression. Due to the large distance between molecules, a doubling of the pressure requires, in order of magnitude, a doubling of the density; i.e.

$$\boxed{\frac{\delta P}{P} = \Gamma \frac{\delta \rho}{\rho} \quad \text{for a gas}}, \quad (13.2)$$

where Γ is a proportionality factor of order unity. The numerical value of Γ depends on the physical situation. If the gas is *ideal* (i.e., *perfect*) [so $P = \rho k_B T / \mu m_p$ in the notation of Box 13.2, Eq. (4)] and the temperature T is being held fixed by thermal contact with some heat source as the density changes (*isothermal process*), then $\delta P \propto \delta \rho$ and $\Gamma = 1$. Alternatively, and much more commonly, a fluid element's entropy might remain constant because no significant heat can flow in or out of it during the density change. In this case Γ is called the *adiabatic index*, and (continuing to assume ideality, $P = \rho k_B T / \mu m_p$), it can be shown using the laws of thermodynamics that

$$\boxed{\Gamma = \gamma \equiv c_P / c_V \quad \text{for adiabatic process in an ideal gas}}. \quad (13.3)$$

Here c_P, c_V are the specific heats at constant pressure and volume; see Ex. 5.4 in Chap. 5.

[In fluid mechanics, our specific heats, and other extensive variables such as energy, entropy and enthalpy, are defined on a per unit mass basis and denoted by lower-case letters; so $c_P = T(\partial s / \partial T)_P$ is the amount of heat that must be added to a unit mass of the fluid to increase its temperature by one unit, and similarly for $c_V = T(\partial s / \partial T)_\rho$. By contrast, in statistical thermodynamics (Chap. 5) our extensive variables are defined for some chosen sample of material and are denoted by capital letters, e.g. $C_P = T(\partial S / \partial T)_P$.]

From Eqs. (13.1) and (13.2), we see that $\Gamma = KP$; so why do we use K for liquids and Γ for gases and plasmas? Because in a liquid K remains nearly constant when P changes by large fractional amounts $\delta P / P \gtrsim 1$, while in a gas or plasma it is Γ that remains nearly constant.

For other thermodynamic aspects of fluid dynamics, which will be very important as we proceed, see Box 13.2.

13.3 Hydrostatics

Just as we began our discussion of elasticity with a treatment of elastostatics, so we will introduce fluid mechanics by discussing hydrostatic equilibrium.

The *equation of hydrostatic equilibrium* for a fluid at rest in a gravitational field \mathbf{g} is the same as the equation of elastostatic equilibrium with a vanishing shear stress, so $\mathbf{T} = P\mathbf{g}$:

$$\boxed{\nabla \cdot \mathbf{T} = \nabla P = \rho \mathbf{g}} \quad (13.4)$$

[Eq. (11.14) with $\mathbf{f} = -\nabla \cdot \mathbf{T}$]. Here \mathbf{g} is the acceleration of gravity (which need not be constant, e.g. it varies from location to location inside the Sun). It is often useful to express \mathbf{g} as the gradient of the Newtonian gravitational potential Φ ,

$$\boxed{\mathbf{g} = -\nabla \Phi} . \quad (13.5)$$

Note our sign convention: Φ is negative near a gravitating body and zero far from all bodies. It is determined by Newton's field equation for gravity

$$\boxed{\nabla^2 \Phi = -\nabla \cdot \mathbf{g} = 4\pi G \rho} . \quad (13.6)$$

From Eq. (13.4), we can draw some immediate and important inferences. Take the curl of Eq. (13.4) and use Eq. (13.5) to obtain

$$\nabla \Phi \times \nabla \rho = 0 . \quad (13.7)$$

This tells us that, in hydrostatic equilibrium, the contours of constant density coincide with the equipotential surfaces, i.e. $\rho = \rho(\Phi)$; and Eq. (13.4) itself, with (13.5), tells us that, as we move from point to point in the fluid, the changes in P and Φ are related by $dP/d\Phi = -\rho(\Phi)$. This, in turn, implies that the difference in pressure between two equipotential surfaces Φ_1 and Φ_2 is given by

$$\Delta P = - \int_{\Phi_1}^{\Phi_2} \rho(\Phi) d\Phi, \quad (13.8)$$

Moreover, as $\nabla P \propto \nabla \Phi$, the surfaces of constant pressure (the *isobars*) coincide with the gravitational equipotentials. This is all true when \mathbf{g} varies inside the fluid, or when it is constant.

The gravitational acceleration \mathbf{g} is actually constant to high accuracy in most non-astronomical applications of fluid dynamics, for example on the surface of the earth. In this case, the pressure at a point in a fluid is, from Eq. (13.8), equal to the total weight of fluid per unit area above the point,

$$P(z) = g \int_z^\infty \rho dz , \quad (13.9)$$

where the integral is performed by integrating upward in the gravitational field; cf. Fig. 13.1. For example, the deepest point in the world's oceans is the bottom of the Marianas trench in the Pacific, 11.03 km. Adopting a density $\rho \simeq 10^3 \text{kg m}^{-3}$ for water and $g \simeq 10 \text{m s}^{-2}$,

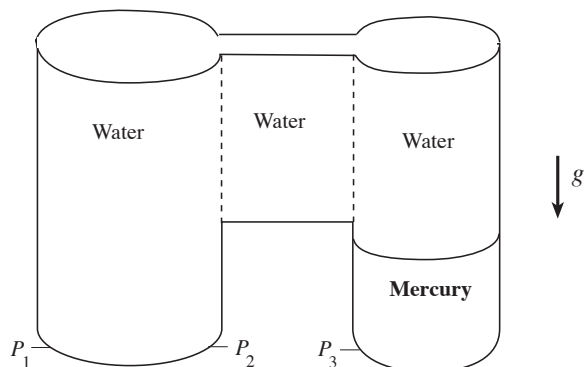

Fig. 13.1: Elementary demonstration of the principles of hydrostatic equilibrium. Water and mercury, two immiscible fluids of different density, are introduced into a container with two connected chambers as shown. In each chamber, isobars (surfaces of constant pressure) coincide with surfaces of constant $\Phi = -gz$, and so are horizontal. The pressure at each point on the flat bottom of a container is equal to the weight per unit area of the overlying fluids [Eq. (13.9)]. The pressures P_1 and P_2 at the bottom of the left chamber are equal, but because of the density difference between mercury and water, they differ from the pressure P_3 at the bottom of the right chamber.

we obtain a pressure of $\simeq 10^8$ Pa or $\simeq 10^3$ atmospheres. This is comparable with the yield stress of the strongest materials. It should therefore come as no surprise to discover that the deepest dive ever recorded by a submersible was made by the *Trieste* in 1960, when it reached a depth of 10.91 km, just a bit shy of the lowest point in the trench. Since the bulk modulus of water is $K = 2.2$ Gpa, at the bottom of the trench the water is compressed by $\delta\rho/\rho = P/K \simeq 5$ per cent.

13.3.1 Archimedes' Law

The Law of Archimedes states that, *when a solid body is totally or partially immersed in a fluid in a uniform gravitational field $\mathbf{g} = -g\mathbf{e}_z$, the total buoyant upward force of the fluid on the body is equal to the weight of the displaced fluid.*

A formal proof can be made as follows; see Fig. 13.2. The fluid, pressing inward on the body across a small element of the body's surface $d\Sigma$, exerts a force $d\mathbf{F}^{\text{buoy}} = \mathbf{T}(\underline{\quad}, -d\Sigma)$ [Eq. (1.33)], where \mathbf{T} is the fluid's stress tensor and the minus sign is because, by convention, $d\Sigma$ points out of the body rather than into it. Converting to index notation and integrating

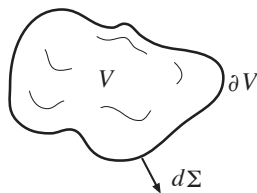

Fig. 13.2: Derivation of Archimedes' Law.

over the body's surface $\partial\mathcal{V}$, we obtain for the net buoyant force

$$F_i^{\text{buoy}} = - \int_{\partial\mathcal{V}} T_{ij} d\Sigma_j . \quad (13.10)$$

Now, imagine removing the body and replacing it by fluid that has the same pressure $P(z)$ and density $\rho(z)$, at each height z , as the surrounding fluid; this is the fluid that was originally displaced by the body. Since the fluid stress on $\partial\mathcal{V}$ has not changed, the buoyant force will be unchanged. Use Gauss's law to convert the surface integral (13.10) into a volume integral over the interior fluid (the originally displaced fluid)

$$F_i^{\text{buoy}} = - \int_{\mathcal{V}} T_{ij;j} dV . \quad (13.11)$$

The displaced fluid obviously is in hydrostatic equilibrium with the surrounding fluid, and its equation of hydrostatic equilibrium $T_{ij;j} = \rho g_i$ [Eq. (13.4)], when inserted into Eq. (13.11), implies that

$$\boxed{\mathbf{F}^{\text{buoy}} = -\mathbf{g} \int_{\mathcal{V}} \rho dV = -M\mathbf{g}} , \quad (13.12)$$

where M is the mass of the displaced fluid. Thus, the upward buoyant force on the original body is equal in magnitude to the weight Mg of the displaced fluid. Clearly, if the body has a higher density than the fluid, then the downward gravitational force on it (its weight) will exceed the weight of the displaced fluid and thus exceed the buoyant force it feels, and the body will fall. If the body's density is less than that of the fluid, the buoyant force will exceed its weight and it will be pushed upward.

A key piece of physics underlying Archimedes law is the fact that the intermolecular forces acting in a fluid, like those in a solid (cf. Sec. 11.3), are of short range. If, instead, the forces were of long range, Archimedes' law could fail. For example, consider a fluid that is electrically conducting, with currents flowing through it that produce a magnetic field and resulting long-range magnetic forces (the magnetohydrodynamic situation studied in Chap. 18). If we then substitute an insulating solid for some region \mathcal{V} of the conducting fluid, the force that acts on the solid will be different from the force that acted on the displaced fluid.

13.3.2 Nonrotating Stars and Planets

Stars and massive planets—if we ignore their rotation—are self-gravitating fluid spheres. We can model the structure of a such non-rotating, spherical, self-gravitating fluid body by combining the equation of hydrostatic equilibrium (13.4) in spherical polar coordinates,

$$\frac{dP}{dr} = -\rho \frac{d\Phi}{dr} , \quad (13.13)$$

with Poisson's equation,

$$\nabla^2\Phi = \frac{1}{r^2} \frac{d}{dr} \left(r^2 \frac{d\Phi}{dr} \right) = 4\pi G\rho , \quad (13.14)$$

to obtain

$$\frac{1}{r^2} \frac{d}{dr} \left(\frac{r^2}{\rho} \frac{dP}{dr} \right) = -4\pi G\rho. \quad (13.15)$$

This can be integrated once radially with the aid of the boundary condition $dP/dr = 0$ at $r = 0$ (pressure cannot have a cusp-like singularity) to obtain

$$\boxed{\frac{dP}{dr} = -\rho \frac{Gm}{r^2}}, \quad (13.16a)$$

where

$$\boxed{m = m(r) \equiv \int_0^r 4\pi\rho r^2 dr} \quad (13.16b)$$

is the total mass inside radius r . Equation (13.16a) is an alternative form of the equation of hydrostatic equilibrium (13.13) at radius r inside the body: Gm/r^2 is the gravitational acceleration g at r , $\rho(Gm/r^2) = \rho g$ is the downward gravitational force per unit volume on the fluid, and dP/dr is the upward buoyant force per unit volume.

Equations (13.13)—(13.16b) are a good approximation for solid planets such as Earth, as well as for stars and fluid planets such as Jupiter, because, at the enormous stresses encountered in the interior of a solid planet, the strains are so large that plastic flow will occur. In other words, the shear stresses are much smaller than the isotropic part of the stress tensor.

Let us make an order of magnitude estimate of the interior pressure in a star or planet of mass M and radius R . We use the equation of hydrostatic equilibrium (13.4) or (13.16a), approximating m by M , the density ρ by M/R^3 and the gravitational acceleration by GM/R^2 ; the result is

$$P \sim \frac{GM^2}{R^4}. \quad (13.17)$$

In order to improve on this estimate, we must solve Eq. (13.15). For that, we need a prescription relating the pressure to the density, i.e. an equation of state. A common idealization is the polytropic relation, namely that

$$P \propto \rho^{1+1/n} \quad (13.18)$$

where n is called the polytropic index (cf. last part of Box 13.2). [This finesses the issue of the generation and flow of heat in stellar interiors, which determines the temperature $T(r)$ and thence the pressure $P(\rho, T)$.] Low mass white dwarf stars are well approximated as $n = 1.5$ polytropes [Eq. (3.50c)], and red giant stars are somewhat similar in structure to $n = 3$ polytropes. The giant planets, Jupiter and Saturn mainly comprise a H-He fluid which is well approximated by an $n = 1$ polytrope, and the density of a small planet like Mercury is very roughly constant ($n = 0$).

In order to solve Eqs. (13.16), we also need boundary conditions. We can choose some density ρ_c and corresponding pressure $P_c = P(\rho_c)$ at the star's center $r = 0$, then integrate Eqs. (13.16) outward until the pressure P drops to zero, which will be the star's (or planet's) surface. The values of r and m there will be the star's radius R and mass M . For mathematical details of polytropic stellar models constructed in this manner see, Ex. 13.4. This

exercise is particularly important as an example of the power of converting to dimensionless variables, a procedure we shall use frequently in this Fluid Part of the book.

We can easily solve the equations of hydrostatic equilibrium (13.16) for a planet with constant density ($n = 0$) to obtain $m = (4\pi/3)\rho r^3$ and

$$P = P_0 \left(1 - \frac{r^2}{R^2} \right), \quad (13.19)$$

where the central pressure is

$$P_0 = \left(\frac{3}{8\pi} \right) \frac{GM^2}{R^4}, \quad (13.20)$$

consistent with our order of magnitude estimate (13.17).

13.3.3 Hydrostatics of Rotating Fluids

The equation of hydrostatic equilibrium (13.4) and the applications of it discussed above are valid only when the fluid is static in a reference frame that is rotationally inertial. However, they are readily extended to bodies that rotate rigidly, with some uniform angular velocity $\boldsymbol{\Omega}$ relative to an inertial frame. In a frame that corotates with the body, the fluid will have vanishing velocity \mathbf{v} , i.e. will be static, and the equation of hydrostatic equilibrium (13.4) will be changed only by the addition of the centrifugal force per unit volume:

$$\boxed{\nabla P = \rho(\mathbf{g} + \mathbf{g}_{\text{cen}}) = -\rho\nabla(\Phi + \Phi_{\text{cen}})}. \quad (13.21)$$

Here

$$\boxed{\mathbf{g}_{\text{cen}} = -\boldsymbol{\Omega} \times (\boldsymbol{\Omega} \times \mathbf{r}) = -\nabla\Phi_{\text{cen}}} \quad (13.22)$$

is the centrifugal acceleration; $\rho\mathbf{g}_{\text{cen}}$ is the centrifugal force per unit volume; and

$$\boxed{\Phi_{\text{cen}} = -\frac{1}{2}(\boldsymbol{\Omega} \times \mathbf{r})^2}. \quad (13.23)$$

is a *centrifugal potential* whose gradient is equal to the centrifugal acceleration in our situation of constant $\boldsymbol{\Omega}$. The centrifugal potential can be regarded as an augmentation of the gravitational potential Φ . Indeed, *in the presence of uniform rotation, all hydrostatic theorems [e.g., Eqs. (13.7) and (13.8)] remain valid with Φ replaced by $\Phi + \Phi_{\text{cen}}$.*

We can illustrate this by considering the shape of a spinning fluid planet. Let us suppose that almost all the mass of the planet is concentrated in its core so the gravitational potential $\Phi = -GM/r$ is unaffected by the rotation. Now, the surface of the planet must be an equipotential of $\Phi + \Phi_{\text{cen}}$ (coinciding with the zero-pressure isobar) [cf. Eq. (13.7) and subsequent sentences, with $\Phi \rightarrow \Phi + \Phi_{\text{cen}}$]. The contribution of the centrifugal potential at the equator is $-\Omega^2 R_e^2/2$ and at the pole it is zero. The difference in the gravitational potential Φ between the equator and the pole is $\simeq g(R_e - R_p)$ where R_e, R_p are the equatorial and polar radii respectively and g is the gravitational acceleration at the planet's surface. Therefore, adopting this centralized-mass model and requiring that $\Phi + \Phi_{\text{cen}}$ be the same at

the equator as at the pole, we estimate the difference between the polar and equatorial radii to be

$$R_e - R_p \simeq \frac{\Omega^2 R^2}{2g}. \quad (13.24)$$

The earth, although not a fluid, is unable to withstand large shear stresses because its shear strain cannot exceed the yield strain of rock, ~ 0.001 ; see the paragraph following Eq. (11.10b). Since the heights of the tallest mountains are also governed by the yield strain, the Earth's surface will not deviate from its equipotential by more than the maximum height of a mountain, $\simeq 9$ km. If we substitute $g \simeq 10 \text{ m s}^{-2}$, $R \simeq 6 \times 10^6 \text{ m}$ and $\Omega \simeq 7 \times 10^{-5} \text{ rad s}^{-1}$, we obtain $R_e - R_p \simeq 10$ km, about half the correct value of 21 km. The reason for this discrepancy lies in our assumption that all the mass resides at the center. In fact, the mass is distributed fairly uniformly in radius and, in particular, some mass is found in the equatorial bulge. This deforms the gravitational equipotential surfaces from spheres to ellipsoids, which accentuates the flattening. If, following Newton (in his *Principia Mathematica* 1687), we assume that the earth has uniform density, then the flattening estimate is 2.5 times larger than our centralized-mass estimate (Ex. 13.5), i.e., $R_e - R_p \simeq 25$ km, in fairly good agreement with the Earth's actual shape.

EXERCISES

Exercise 13.1 *Practice: Weight in Vacuum*

How much more would you weigh *in vacuo*?

Exercise 13.2 *Example: Earth's Atmosphere*

As mountaineers know, it gets cooler as you climb. However, the rate at which the temperature falls with altitude depends on the thermal properties of air. Consider two limiting cases.

- (a) In the lower stratosphere (Fig. 13.3), the air is isothermal. Use the equation of hydrostatic equilibrium (13.4) to show that the pressure decreases exponentially with height z

$$P \propto \exp(-z/H),$$

where the scale height H is given by

$$H = \frac{k_B T}{\mu m_p g}$$

and μ is the mean molecular weight of air and m_p is the proton mass. Evaluate this numerically for the lower stratosphere and compare with the stratosphere's thickness. By how much does P drop between the bottom and top of the isothermal region?

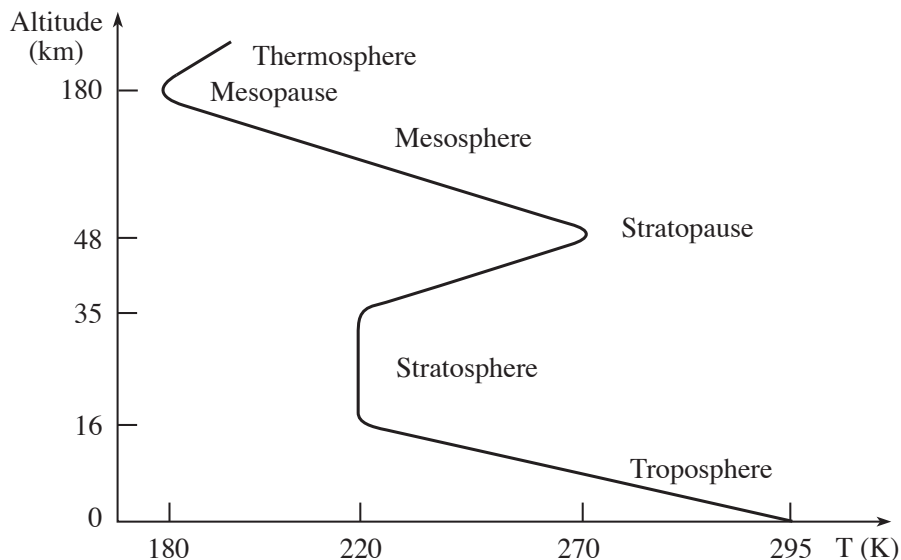

Fig. 13.3: Actual temperature variation of the Earth's mean atmosphere at temperate latitudes.

- (b) Suppose that the air is isentropic so that $P \propto \rho^\gamma$ [Eq. (6) of Box 13.2], where γ is the specific heat ratio. (For diatomic gases like nitrogen and oxygen, $\gamma \sim 1.4$.) Show that the temperature gradient satisfies

$$\frac{dT}{dz} = -\frac{\gamma - 1}{\gamma} \frac{g\mu m_p}{k}.$$

Note that the temperature gradient vanishes when $\gamma \rightarrow 1$. Evaluate the temperature gradient, also known, at low altitudes, as the *lapse rate*. The average lapse rate is measured to be $\sim 6\text{K km}^{-1}$ (Fig. 13.3). Show that this is intermediate between the two limiting cases of an isentropic and isothermal lapse rate.

Exercise 13.3 *Problem: Stability of Boats*

Use Archimedes Law to explain qualitatively the conditions under which a boat floating in still water will be stable to small rolling motions from side to side. [Hint, you might want to introduce a *center of buoyancy* and a *center of gravity* inside the boat, and pay attention to the change in the center of buoyancy when the boat tilts. See Fig. 13.4.]

Exercise 13.4 ****Example: Polytropes — The Power of Dimensionless Variables*

When dealing with differential equations describing a physical system, it is often helpful to convert to dimensionless variables. Polytropes (nonrotating, spherical fluid bodies with the polytropic equation of state $P = K\rho^{1+1/n}$) are a nice example.

- (a) Combine the two equations of stellar structure (13.16) to obtain a single second-order differential equation for P and ρ as functions of r .

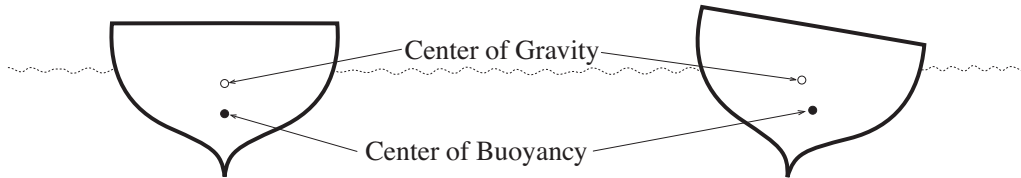

Fig. 13.4: Stability of a Boat. We can understand the stability of a boat to small rolling motions by defining both a center of gravity for weight of the boat and also a center of buoyancy for the upthrust exerted by the water.

- (b) In this equation set $P = K\rho^{1+1/n}$ to obtain a nonlinear, second-order differential equation for $\rho(r)$.
- (c) It is helpful to change dependent variables from $\rho(r)$ to some other variable, call it $\theta(r)$, so chosen that the quantity being differentiated is linear in θ and the only θ -nonlinearity is in the driving term. Show that choosing $\rho \propto \theta^n$ achieves this.
- (d) It is helpful to choose the proportionality constant in $\rho \propto \theta^n$ in such a way that θ is dimensionless and takes the value 1 at the polytrope's center and 0 at its surface. This is achieved by setting

$$\rho = \rho_c \theta^n, \quad (13.25a)$$

where ρ_c is the polytrope's (possibly unknown) central density.

- (e) Similarly, it is helpful to make the independent variable r dimensionless by setting $r = a\xi$, where a is a constant with dimensions of length. The value of a should be chosen wisely, so as to simplify the differential equation as much as possible. Show that the choice

$$r = a\xi, \quad \text{where } a = \left[\frac{(n+1)K\rho_c^{(1/n-1)}}{4\pi G} \right]^{1/2}, \quad (13.25b)$$

brings the differential equation into the form

$$\frac{1}{\xi^2} \frac{d}{d\xi} \xi^2 \frac{d\theta}{d\xi} = -\theta^n. \quad (13.26)$$

This is called the *Lane-Emden equation of stellar structure*, after Jonathan Homer Lane and Jacob Robert Emden, who introduced and explored it near the end of the 19th century. There is an extensive literature on solutions of the Lane-Emden equation; see, especially, Chap. 4 of Chandrasekhar (1939) and Sec. 3.3 of Shapiro and Teukolsky (1984).

- (f) Explain why the Lane-Emden equation must be solved subject to the following boundary conditions (where $\theta' \equiv d\theta/d\xi$):

$$\theta = \theta' = 0 \text{ at } \xi = 0. \quad (13.27)$$

- (g) One can integrate the Lane-Emden equation, numerically or analytically, outward from $\xi = 0$ until some radius ξ_1 at which θ (and thus also ρ and P) goes to zero. That is the Polytrope's surface. Its physical radius is then $R = a\xi_1$, and its mass is $M = \int_0^R 4\pi\rho r^2 dr$, which is readily shown to be $M = 4\pi a^3 \rho_c \xi_1^2 |\theta'(\xi_1)|$; i.e., using the value (13.25b) of a :

$$R = \left[\frac{(n+1)K}{4\pi G} \right]^{1/2} \rho_c^{(1-n)/2n} \xi_1, \quad M = 4\pi \left[\frac{(n+1)K}{4\pi G} \right]^{3/2} \rho_c^{(3-n)/2n} \xi_1^2 |\theta'(\xi_1)|, \quad (13.28a)$$

$$\text{whence } M = 4\pi R^{(3-n)/(1-n)} \left[\frac{(n+1)K}{4\pi G} \right]^{n/(n-1)} \xi_1^2 |\theta'(\xi_1)|. \quad (13.28b)$$

- (h) Whenever one converts a problem into dimensionless variables that satisfy some differential or algebraic equation(s), and then expresses physical quantities in terms of the dimensionless variables, the resulting expressions describe how the physical quantities scale with each other. As an example: Jupiter and Saturn are both comprised of a H-He fluid that is well approximated by a polytrope of index $n = 1$, $P = K\rho^2$, with the same constant K . Use the information that $M_J = 2 \times 10^{27} \text{kg}$, $R_J = 7 \times 10^4 \text{km}$, $M_S = 6 \times 10^{26} \text{kg}$, to estimate the radius of Saturn. For $n = 2$, the Lane-Emden equation has a simple analytical solution, $\theta = \sin(\xi)/\xi$. Compute the central densities of Jupiter and Saturn.

Exercise 13.5 *Example: Shape of a constant density, spinning planet*

- (a) Show that the spatially variable part of the gravitational potential for a uniform-density, non-rotating planet can be written as $\Phi = 2\pi G\rho r^2/3$, where ρ is the density.
- (b) Hence argue that the gravitational potential for a slowly spinning planet can be written in the form

$$\Phi = \frac{2\pi G\rho r^2}{3} + Ar^2 P_2(\mu)$$

where A is a constant and P_2 is a Legendre polynomial with argument $\mu = \sin(\text{latitude})$. What happens to the P_1 term?

- (c) Give an equivalent expansion for the potential outside the planet.
- (d) Now transform into a frame spinning with the planet and add the centrifugal potential to give a total potential.
- (e) By equating the potential and its gradient at the planet's surface, show that the difference between the polar and the equatorial radii is given by

$$R_e - R_p \simeq \frac{5\Omega^2 R^2}{4g},$$

where g is the gravitational acceleration at the surface. Note that this is 5/2 times the answer for a planet whose mass is all concentrated at its center [Eq. (13.24)].

Exercise 13.6 *Problem: Shapes of Stars in a Tidally Locked Binary System*

Consider two stars, with the same mass M orbiting each other in a circular orbit with diameter (separation between the stars' centers) a . Kepler's laws tell us that the stars' orbital angular velocity is $\Omega = \sqrt{2GM/a^3}$. Assume that each star's mass is concentrated near its center so that everywhere except near a star's center the gravitational potential, in an inertial frame, is $\Phi = -GM/r_1 - GM/r_2$ with r_1 and r_2 the distances of the observation point from the center of star 1 and star 2. Suppose that the two stars are "tidally locked", i.e. tidal gravitational forces have driven them each to rotate with rotational angular velocity equal to the orbital angular velocity Ω . (The moon is tidally locked to the earth; that is why it always keeps the same face toward the earth.) Then in a reference frame that rotates with angular velocity Ω , each star's gas will be at rest, $\mathbf{v} = 0$.

- (a) Write down the total potential $\Phi + \Phi_{\text{cen}}$ for this binary system in the rotating frame.
- (b) Using Mathematica or Maple or some other computer software, plot the equipotentials $\Phi + \Phi_{\text{cen}} = (\text{constant})$ for this binary in its orbital plane, and use these equipotentials to describe the shapes that these stars will take if they expand to larger and larger radii (with a and M held fixed). You should obtain a sequence in which the stars, when compact, are well separated and nearly round; and as they grow, tidal gravity elongates them, ultimately into tear-drop shapes followed by merger into a single, highly distorted star. With further expansion there should come a point where the merged star starts flinging mass off into the surrounding space (a process not included in this hydrostatic analysis).

13.4 Conservation Laws

As a foundation for the transition from hydrostatics to hydrodynamics [to situations with nonzero fluid velocity $\mathbf{v}(\mathbf{x}, t)$], we shall give a general discussion of Newtonian conservation laws, focusing especially on the conservation of mass and of linear momentum.

We begin with the differential law of mass conservation,

$$\boxed{\frac{\partial \rho}{\partial t} + \nabla \cdot (\rho \mathbf{v}) = 0}, \quad (13.29)$$

which we met and used in our study of elastic media [Eq. (12.2c)]. This is the obvious analog of the laws of conservation of charge $\partial \rho_e / \partial t + \nabla \cdot \mathbf{j} = 0$ and of particles $\partial n / \partial t + \nabla \cdot \mathbf{S} = 0$, which we met in Chap. 1 [Eqs. (1.31)]. In each case the law says $(\partial / \partial t)(\text{density of something}) = \nabla \cdot (\text{flux of that something})$. This, in fact, is the universal form for a differential conservation law.

Each Newtonian differential conservation law has a corresponding integral conservation law (Sec. 1.8), which we obtain by integrating the differential law over some arbitrary 3-dimensional volume \mathcal{V} , e.g. the volume used in Fig. 13.2 above to discuss Archimedes' Law:

$(d/dt) \int_{\mathcal{V}} \rho dV = \int_{\mathcal{V}} (\partial\rho/\partial t) dV = - \int_{\mathcal{V}} \nabla \cdot (\rho \mathbf{v}) dV$. Applying Gauss's law to the last integral, we obtain

$$\boxed{\frac{d}{dt} \int_{\mathcal{V}} \rho dV = - \int_{\partial\mathcal{V}} \rho \mathbf{v} \cdot d\boldsymbol{\Sigma}}, \quad (13.30)$$

where $\partial\mathcal{V}$ is the closed surface bounding \mathcal{V} . The left side is the rate of change of mass inside the region \mathcal{V} . The right side is the rate at which mass flows into \mathcal{V} through $\partial\mathcal{V}$ (since $\rho \mathbf{v}$ is the mass flux, and the inward pointing surface element is $-d\boldsymbol{\Sigma}$). This is the same argument, connecting differential to integral conservation laws, as we gave in Eqs. (1.30) and (1.31) for electric charge and for particles, but going in the opposite direction. And this argument depends in no way on whether the flowing material is a fluid or not. The mass conservation laws (13.29) and (13.30) are valid for any kind of material whatsoever.

Writing the differential conservation law in the form (13.29), where we monitor the changing density at a given location in space rather than moving with the material, is called the *Eulerian* approach. There is an alternative *Lagrangian* approach to mass conservation, in which we focus on changes of density as measured by somebody who moves, locally, with the material, i.e. with velocity \mathbf{v} . We obtain this approach by differentiating the product $\rho \mathbf{v}$ in Eq. (13.29), to obtain

$$\boxed{\frac{d\rho}{dt} = -\rho \nabla \cdot \mathbf{v}}, \quad (13.31)$$

where

$$\boxed{\frac{d}{dt} \equiv \frac{\partial}{\partial t} + \mathbf{v} \cdot \nabla}. \quad (13.32)$$

The operator d/dt is known as the *convective time derivative* (or *advective time derivative*) and crops up often in continuum mechanics. Its physical interpretation is very simple. Consider first the partial derivative $(\partial/\partial t)_{\mathbf{x}}$. This is the rate of change of some quantity [the density ρ in Eq. (13.31)] at a fixed point in space in some reference frame. In other words, if there is motion, $\partial/\partial t$ compares this quantity at the same point \mathcal{P} in space for two different points in the material: one that was at \mathcal{P} at time $t + dt$; the other that was at \mathcal{P} at the earlier time t . By contrast, the convective time derivative (d/dt) follows the motion, taking the difference in the value of the quantity at successive times at the same point in the moving matter. It therefore measures the rate of change of ρ (or any other quantity) following the material rather than at a fixed point in space; it is the time derivative for the Lagrangian approach. Note that the convective derivative d/dt is the Newtonian limit of relativity's proper time derivative along the world line of a bit of matter, $d/d\tau = u^\alpha \partial/\partial x^\alpha = (dx^\alpha/d\tau) \partial/\partial x^\alpha$ [Secs. 2.4.1 and 2.6].

The Lagrangian approach can also be expressed in terms of fluid elements. Consider a fluid element, with a bounding surface attached to the fluid, and denote its volume by ΔV . The mass inside the fluid element is $\Delta M = \rho \Delta V$. As the fluid flows, this mass must be conserved, so $d\Delta M/dt = (d\rho/dt)\Delta V + \rho(d\Delta V/dt) = 0$, which we can rewrite as

$$\frac{d\rho}{dt} = -\rho \frac{d\Delta V/dt}{\Delta V}. \quad (13.33)$$

Comparing with Eq. (13.31), we see that

$$\boxed{\nabla \cdot \mathbf{v} = \frac{d\Delta V/dt}{\Delta V}}. \quad (13.34)$$

Thus, the divergence of \mathbf{v} is the fractional rate of increase of a fluid element's volume. Notice that this is just the time derivative of our elastostatic equation $\Delta V/V = \nabla \cdot \boldsymbol{\xi} = \Theta$ [Eq. (11.8)] (since $\mathbf{v} = d\boldsymbol{\xi}/dt$), and correspondingly we denote

$$\boxed{\nabla \cdot \mathbf{v} \equiv \theta = d\Theta/dt}, \quad (13.35)$$

and call it the fluid's *rate of expansion*.

Equation (13.29) is our model for Newtonian conservation laws. It says that there is a quantity, in this case *mass*, with a certain density, in this case ρ , and a certain flux, in this case $\rho\mathbf{v}$, and this quantity is neither created nor destroyed. The temporal derivative of the density (at a fixed point in space) added to the divergence of the flux must vanish. Of course, not all physical quantities have to be conserved. If there were sources or sinks of mass, then these would be added to the right hand side of Eq. (13.29).

Turn, now, to momentum conservation. The (Newtonian) law of momentum conservation must take the standard conservation-law form $(\partial/\partial t)(\text{momentum density}) + \nabla \cdot (\text{momentum flux}) = 0$.

If we just consider the *mechanical momentum* associated with the motion of mass, its density is the vector field $\rho\mathbf{v}$. There can also be other forms of momentum density, e.g. electromagnetic, but these do not enter into Newtonian fluid mechanics. For fluids, as for an elastic medium (Chap. 12), the momentum density is simply $\rho\mathbf{v}$.

The momentum flux is more interesting and rich. Quite generally it is, by definition, the stress tensor \mathbf{T} , and the differential conservation law says

$$\boxed{\frac{\partial(\rho\mathbf{v})}{\partial t} + \nabla \cdot \mathbf{T} = 0}. \quad (13.36)$$

[Eq. (1.36)]. For an elastic medium, $\mathbf{T} = -K\Theta\mathbf{g} - 2\mu\boldsymbol{\Sigma}$ [Eq. (11.18)] and the conservation law (13.36) gives rise to the elastodynamic phenomena that we explored in Chap. 12. For a fluid we shall build up \mathbf{T} piece by piece:

We begin with the rate $d\mathbf{p}/dt$ that mechanical momentum flows through a small element of surface area $d\boldsymbol{\Sigma}$, from its back side to its front (i.e. the rate that it flows in the “positive sense”; cf. Fig. 2.11b). The rate that mass flows through is $\rho\mathbf{v} \cdot d\boldsymbol{\Sigma}$, and we multiply that mass by its velocity \mathbf{v} to get the momentum flow rate: $d\mathbf{p}/dt = (\rho\mathbf{v})(\mathbf{v} \cdot d\boldsymbol{\Sigma})$. This rate of flow of momentum is the same thing as a force $\mathbf{F} = d\mathbf{p}/dt$ acting across $d\boldsymbol{\Sigma}$; so it can be computed by inserting $d\boldsymbol{\Sigma}$ into the second slot of a “mechanical” stress tensor \mathbf{T}_m : $d\mathbf{p}/dt = \mathbf{T}_m(_, d\boldsymbol{\Sigma})$ [cf. the definition (1.33) of the stress tensor]. By writing these two expressions for the momentum flow in index notation, $dp_i/dt = (\rho v_i)v_j d\Sigma_j = T_{ij}d\Sigma_j$, we read off the mechanical stress tensor: $T_{ij} = \rho v_i v_j$; i.e.,

$$\boxed{\mathbf{T}_m = \rho\mathbf{v} \otimes \mathbf{v}}. \quad (13.37)$$

This tensor is symmetric (as any stress tensor must be; Sec. 1.9), and it obviously is the flux of mechanical momentum since it has the form (momentum density) \otimes (velocity).

Let us denote by \mathbf{f} the net force per unit volume that acts on the fluid. Then, instead of writing momentum conservation in the usual Eulerian differential form (13.36), we can write it as

$$\frac{\partial(\rho\mathbf{v})}{\partial t} + \nabla \cdot \mathbf{T}_m = \mathbf{f}, \quad (13.38)$$

(conservation law with a source on the right hand side!). Inserting $\mathbf{T}_m = \rho\mathbf{v} \otimes \mathbf{v}$ into this equation, converting to index notation, using the rule for differentiating products, and combining with the law of mass conservation, we obtain the *Lagrangian law*

$$\boxed{\rho \frac{d\mathbf{v}}{dt} = \mathbf{f}}. \quad (13.39)$$

Here $d/dt = \partial/\partial t + \mathbf{v} \cdot \nabla$ is the convective time derivative, i.e. the time derivative moving with the fluid; so this equation is just Newton's "F=ma", per unit volume. In order for the equivalent versions (13.38) and (13.39) of momentum conservation to also be equivalent to the Eulerian formulation (13.36), it must be that there is a stress tensor \mathbf{T}_f such that

$$\boxed{\mathbf{f} = -\nabla \cdot \mathbf{T}_f; \quad \text{and} \quad \mathbf{T} = \mathbf{T}_m + \mathbf{T}_f}. \quad (13.40)$$

Then Eq. (13.38) becomes the Eulerian conservation law (13.36).

Evidently, a knowledge of the stress tensor \mathbf{T}_f for some material is equivalent to a knowledge of the force density \mathbf{f} that acts on it. Now, it often turns out to be much easier to figure out the form of the stress tensor, for a given situation, than the form of the force. Correspondingly, as we add new pieces of physics to our fluid analysis (isotropic pressure, viscosity, gravity, magnetic forces), an efficient way to proceed at each stage is to insert the relevant physics into the stress tensor \mathbf{T} , and then evaluate the resulting contribution $\mathbf{f} = -\nabla \cdot \mathbf{T}_f$ to the force and thence to the Lagrangian law of force balance (13.39). At each step, *we get out in the form* $\mathbf{f} = -\nabla \cdot \mathbf{T}_f$ *the physics that we put into* \mathbf{T}_f .

There may seem something tautological about the procedure (13.40) by which we went from the Lagrangian "F=ma" equation (13.39) to the Eulerian conservation law (13.36). The "F=ma" equation makes it look like mechanical momentum is not be conserved in the presence of the force density \mathbf{f} . But we make it be conserved by introducing the momentum flux \mathbf{T}_f . It is almost as if we regard conservation of momentum as a principle to be preserved at all costs and so every time there appears to be a momentum deficit, we simply define it as a bit of the momentum flux. This, however, is not the whole story. What is important is that the force density \mathbf{f} can always be expressed as the divergence of a stress tensor; that fact is central to the nature of force and of momentum conservation. An erroneous formulation of the force would not necessarily have this property and there would not be a differential conservation law. So the fact that we *can* create elastostatic, thermodynamic, viscous, electromagnetic, gravitational etc. contributions to some grand stress tensor (that go to zero outside the regions occupied by the relevant matter or fields), as we shall see in the coming chapters, *is* significant and affirms that our physical model is complete at the level of approximation to which we are working.

We can proceed in the same way with energy conservation as we have with momentum. There is an energy density $U(\mathbf{x}, t)$ for a fluid and an energy flux $\mathbf{F}(\mathbf{x}, t)$, and they obey a conservation law with the standard form

$$\boxed{\frac{\partial U}{\partial t} + \nabla \cdot \mathbf{F} = 0}. \quad (13.41)$$

At each stage in our buildup of fluid mechanics (adding, one by one, the influences of compressional energy, viscosity, gravity, magnetism), we can identify the relevant contributions to U and \mathbf{F} and then grind out the resulting conservation law (13.41). At each stage we get out the physics that we put into U and \mathbf{F} .

We conclude with a remark about relativity. In going from Newtonian physics (this chapter) to special relativity (Chap. 2), mass and energy get combined (added) to form a conserved mass-energy or total energy. That total energy and the momentum are the temporal and spatial parts of a spacetime 4-vector, the 4-momentum; and correspondingly, the conservation laws for mass [Eq. (13.29)], nonrelativistic energy [Eq. (13.41)], and momentum [Eq. (13.36)] get unified into a single conservation law for 4-momentum, which is expressed as the vanishing 4-dimensional, spacetime divergence of the 4-dimensional stress-energy tensor (Sec. 2.13; see also Sec. 13.8 below).

13.5 The Dynamics of an Ideal Fluid

We now use the general conservation laws of the last section to derive the fundamental equations of fluid dynamics. We shall do so in several stages. In this section and Sec. 13.6, we will confine our attention to *ideal* fluids, i.e., flows for which it is safe to ignore dissipative processes (viscosity and thermal conductivity), and for which, therefore, the entropy of a fluid element remains constant with time. In Sec. 13.7, we will introduce the effects of viscosity and diffusive heat flow.

13.5.1 Mass Conservation

Mass conservation, as we have seen, takes the (Eulerian) form $\partial\rho/\partial t + \nabla \cdot (\rho\mathbf{v}) = 0$ [Eq. (13.29)], or equivalently the (Lagrangian) form $d\rho/dt = -\rho\nabla \cdot \mathbf{v}$ [Eq. (13.31)], where $d/dt = \partial/\partial t + \mathbf{v} \cdot \nabla$ is the convective time derivative (moving with the fluid) [Eq. (13.32)].

We define a fluid to be *incompressible* when $d\rho/dt = 0$. *Note:* incompressibility does *not* mean that the fluid cannot be compressed; rather, it merely means that in the situation being studied, the density of each fluid element remains (very nearly) constant as time passes. From Eq. (13.32), we see that incompressibility implies that the velocity field has vanishing divergence (i.e. it is *solenoidal*, i.e. expressible as the curl of some potential). The condition that the fluid be incompressible is a weaker condition than that the density be constant everywhere; for example, the density varies substantially from the earth's center to its surface, but if the material inside the earth were moving more or less on surfaces of constant radius, the flow would be incompressible. As we shall see in Sec. 13.6, approximating a flow as incompressible is a good approximation when the flow speed is much less than the speed

of sound and the fluid does not move through too great gravitational potential differences. During large portions of our study of fluid mechanics, we shall assume incompressibility, but we shall *not* make this assumption in the remainder of Sec. 13.5.

13.5.2 Momentum Conservation

For an ideal fluid, the only forces that can act are those of gravity and of the fluid's isotropic pressure P . We have already met and discussed the contribution of P to the stress tensor, $\mathbf{T} = P\mathbf{g}$, when dealing with elastic media (Chap. 11) and in hydrostatics (Sec. 13.3). The gravitational force density, $\rho\mathbf{g}$, is so familiar that it is easier to write it down than the corresponding gravitational contribution to the stress. Correspondingly, we can most easily write momentum conservation in the form

$$\frac{\partial(\rho\mathbf{v})}{\partial t} + \nabla \cdot \mathbf{T} = \rho\mathbf{g} ; \quad \text{i.e.} \quad \frac{\partial(\rho\mathbf{v})}{\partial t} + \nabla \cdot (\rho\mathbf{v} \otimes \mathbf{v} + P\mathbf{g}) = \rho\mathbf{g} , \quad (13.42)$$

where the stress tensor is given by

$$\boxed{\mathbf{T} = \rho\mathbf{v} \otimes \mathbf{v} + P\mathbf{g} \quad \text{for an ideal fluid}} \quad (13.43)$$

[cf. Eqs. (13.37), (13.38) and (13.4)]. The first term, $\rho\mathbf{v} \otimes \mathbf{v}$, is the mechanical momentum flux (also called the *kinetic* stress), and the second, $P\mathbf{g}$, is that associated with the fluid's pressure.

In most of our applications, the gravitational field \mathbf{g} will be externally imposed, i.e., it will be produced by some object such as the Earth that is different from the fluid we are studying. However, the law of momentum conservation remains the same, Eq. (13.42), independently of what produces gravity, the fluid or an external body or both. And independently of its source, one can write the stress tensor \mathbf{T}_g for the gravitational field \mathbf{g} in a form presented and discussed in track-two Box 13.4 below — a form that has the required property $-\nabla \cdot \mathbf{T}_g = \rho\mathbf{g}$ = (the gravitational force density).

13.5.3 Euler Equation

The “Euler equation” is the equation of motion that one gets out of the momentum conservation law (13.42) for an ideal fluid by performing the differentiations and invoking mass conservation (13.29):

$$\boxed{\frac{d\mathbf{v}}{dt} = -\frac{\nabla P}{\rho} + \mathbf{g} \quad \text{for an ideal fluid}} . \quad (13.44)$$

This Euler equation was first derived in 1785 by the Swiss mathematician and physicist Leonhard Euler.

The Euler equation has a very simple physical interpretation: $d\mathbf{v}/dt$ is the convective derivative of the velocity, i.e. the derivative moving with the fluid, which means it is the acceleration felt by the fluid. This acceleration has two causes: gravity, \mathbf{g} , and the pressure gradient ∇P . In a hydrostatic situation, $\mathbf{v} = 0$, the Euler equation reduces to the equation of hydrostatic equilibrium, $\nabla P = \rho\mathbf{g}$ [Eq. (13.4)].

In Cartesian coordinates, the Euler equation (13.44) and mass conservation (13.29) comprise four equations in five unknowns, ρ, P, v_x, v_y, v_z . In order to close this system of equations (i.e. to have the same number of equations as unknowns), we must relate P to ρ . For an ideal fluid, we use the fact that the entropy of each fluid element is conserved (because there is no mechanism for dissipation),

$$\frac{ds}{dt} = 0, \quad (13.45)$$

together with an equation of state for the pressure in terms of the density and the entropy, $P = P(\rho, s)$. In practice, the equation of state is often well approximated by incompressibility, $\rho = \text{constant}$, or by a polytropic relation, $P = K(s)\rho^{1+1/n}$ [Eq. (13.18)].

13.5.4 Bernoulli's Theorem

Bernoulli's theorem is well known. Less well appreciated are the conditions under which it is true. To deduce these, we must first introduce a kinematic quantity known as the *vorticity*,

$$\boldsymbol{\omega} \equiv \nabla \times \mathbf{v}. \quad (13.46)$$

The physical interpretation of vorticity is simple: Consider a small fluid element. As it moves and deforms over a tiny period of time δt , each bit of fluid inside it undergoes a tiny displacement $\boldsymbol{\xi} = \mathbf{v}\delta t$. That displacement field can be decomposed into an expansion, rotation, and shear (as we discussed in the context of an elastic medium in Sec. 11.2.2). The vectorial angle of the rotation is $\phi = \frac{1}{2}\nabla \times \boldsymbol{\xi}$ [Eq. (11.10b)]. The time derivative of that vectorial angle $d\phi/dt = \frac{1}{2}d\boldsymbol{\xi}/dt = \frac{1}{2}\nabla \times \mathbf{v}$ is obviously the fluid element's rotational angular velocity, whence *the vorticity* $\boldsymbol{\omega} = \nabla \times \mathbf{v}$ *is twice the angular velocity of rotation of a fluid element*. Vorticity plays a major role in fluid mechanics, as we shall see in Chap. 14.

To derive Bernoulli's theorem (with the aid of vorticity), we begin with the Euler equation $d\mathbf{v}/dt = -(1/\rho)\nabla P + \mathbf{g}$; we express \mathbf{g} as $-\nabla\Phi$; we convert the convective derivative of velocity (i.e. the acceleration) into its two parts $d\mathbf{v}/dt = \partial\mathbf{v}/\partial t + (\mathbf{v} \cdot \nabla)\mathbf{v}$; and we rewrite $(\mathbf{v} \cdot \nabla)\mathbf{v}$ using the vector identity

$$\mathbf{v} \times \boldsymbol{\omega} \equiv \mathbf{v} \times (\nabla \times \mathbf{v}) = \frac{1}{2}\nabla v^2 - (\mathbf{v} \cdot \nabla)\mathbf{v}. \quad (13.47)$$

The result is

$$\frac{\partial\mathbf{v}}{\partial t} + \nabla\left(\frac{1}{2}v^2 + \Phi\right) + \frac{\nabla P}{\rho} - \mathbf{v} \times \boldsymbol{\omega} = 0. \quad (13.48)$$

This is just the Euler equation written in a new form, but it is also *the most general version of Bernoulli's theorem*. Two special cases are of interest:

Bernoulli's Theorem for Steady Flow of An Ideal Fluid

A steady flow is one in which $\partial(\text{everything})/\partial t = 0$, and an ideal fluid is one in which dissipation (due to viscosity and heat flow) can be ignored. Ideality implies that the entropy

is constant following the flow, i.e. $ds/dt = (\mathbf{v} \cdot \nabla)\mathbf{s} = 0$. From the thermodynamic identity, $dh = Tds + dP/\rho$ [Eq. (3) of Box 13.2] we obtain

$$(\mathbf{v} \cdot \nabla)P = \rho(\mathbf{v} \cdot \nabla)h. \quad (13.49)$$

(Remember that the flow is steady so there are no time derivatives.) We define the *Bernoulli function*, B , by

$$\boxed{B \equiv \frac{1}{2}v^2 + h + \Phi}. \quad (13.50)$$

This allows us to take the scalar product of the gradient of Eq. (13.50) with the velocity \mathbf{v} and thereby rewrite Eq. (13.48) in the form

$$\frac{dB}{dt} = (\mathbf{v} \cdot \nabla)B = 0, \quad (13.51)$$

This says that the Bernoulli function, like the entropy, does not change with time when moving with a fluid element.

Let us define *streamlines*, analogous to lines of force of a magnetic field, by the differential equations

$$\frac{dx}{v_x} = \frac{dy}{v_y} = \frac{dz}{v_z} \quad (13.52)$$

In the language of Sec. 1.5, these are just the integral curves of the (steady) velocity field; they are also the spatial world lines of fluid elements. Equation (13.51) says: ***In a steady flow of an ideal fluid, the Bernoulli function B is constant along streamlines.*** [*Important side remark:* streamlines are a powerful way to visualize fluid flows. There are other ways, sketched in Box 13.3.]

The Bernoulli function $B = \frac{1}{2}v^2 + h + \Phi = \frac{1}{2}v^2 + u + \Phi + P/\rho$ has a simple physical meaning: It is the fluid's total energy density (kinetic plus internal plus potential) per unit mass, plus the work $P(1/\rho)$ that must be done in order to inject a unit mass of fluid (with volume $1/\rho$) into surrounding fluid that has pressure P . This goes hand in hand with the enthalpy $h = u + P/\rho$ being the *injection energy* (per unit mass) in the absence of kinetic and potential energy; see the last part of Ex. 5.5. This meaning of B leads to the following physical interpretation of the constancy of B for a stationary, ideal flow:

Consider a *stream tube* made of a bundle of streamlines (Fig. 13.5). A fluid element with unit mass occupies region \mathcal{A} of the stream tube at some early time, and has moved into region \mathcal{B} at some later time. When it vacates region \mathcal{A} , the fluid element carries with itself

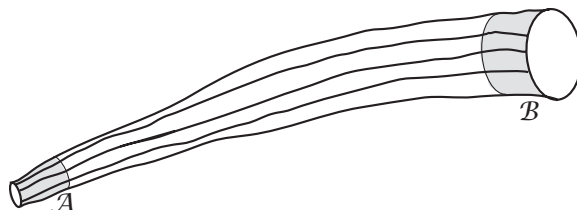

Fig. 13.5: A flow tube used to explain the Bernoulli Theorem for stationary flow of an ideal fluid.

Box 13.3 Flow Visualization

There are various methods for visualizing fluid flows. One way is via *streamlines*, which are the integral curves of the velocity field \mathbf{v} at a given time [Eq. (13.52)]. Streamlines are the analog of magnetic lines of force. They will coincide with the *paths* of individual fluid elements if the flow is stationary. However, when the flow is time-dependent, the fluid-element paths will not be the same as the streamlines. In general, the paths will be the solutions of the equations

$$\frac{d\mathbf{x}}{dt} = \mathbf{v}(\mathbf{x}, t). \quad (1)$$

These paths are the analog of particle trajectories in mechanics.

Yet another type of flow line is a *streak*. This is a common way of visualizing a flow experimentally. Streaks are usually produced by introducing some colored or fluorescent tracer into the flow continuously at some fixed point, say \mathbf{x}_0 , and observing the locus of the tracer at some fixed time, say t_0 . Now, if $\mathbf{x}(t; \mathbf{x}_0, t_0)$ is the expression for the location of a particle released at time t at \mathbf{x}_0 and observed at time t_0 , then the equation for the streak emanating from \mathbf{x}_0 and observed at time t_0 is the parametric relation

$$\mathbf{x}(t) = \mathbf{x}(t; \mathbf{x}_0, t_0)$$

Streamlines, paths and streaks are sketched below.

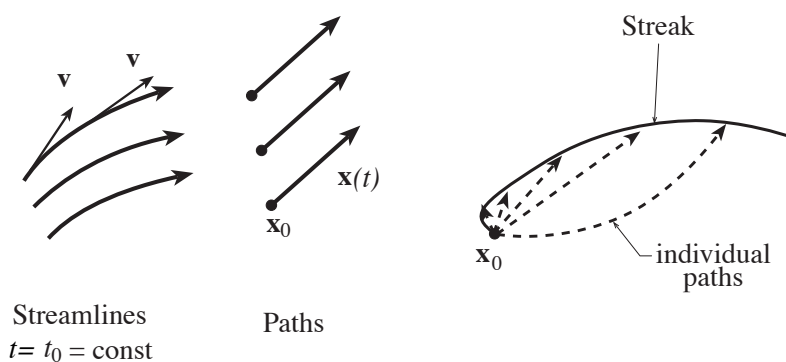

an energy B [including the energy $P(1/\rho)$ it acquires by being squeezed out of \mathcal{A} by the pressure of the surrounding fluid]. When it moves into region \mathcal{B} , it similarly carries with itself the total injection energy B . Because the flow is steady, the energy it extracts from \mathcal{A} must be precisely what it needs to occupy \mathcal{B} , i.e., B must be constant along the stream tube, and hence also along each streamline in the tube.

The most immediate consequence of Bernoulli's theorem is that, if gravity is having no significant effect, then *the enthalpy falls when the speed increases, and conversely*. This is just the conversion of internal (injection) energy into bulk kinetic energy, and conversely.

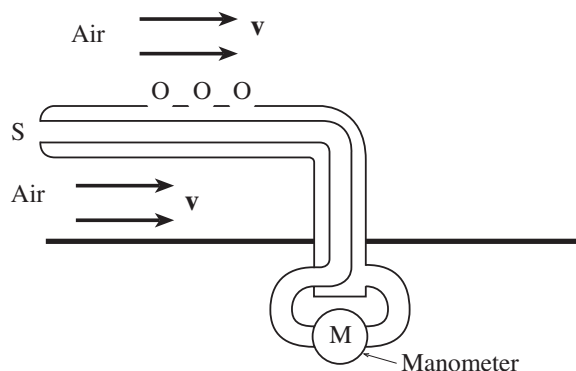

Fig. 13.6: Schematic illustration of a Pitot tube used to measure air speed. The tube points into the flow well away from the boundary layer. A manometer measures the pressure difference between the stagnation points S, where the external velocity is very small, and several orifices O in the side of the tube where the pressure is almost equal to that in the free air flow. The air speed can then be inferred by application of the Bernoulli theorem.

For our ideal fluid, entropy must be conserved moving with a fluid element, so the first law of thermodynamics says $dh = Tds + dP/\rho = dP/\rho$. Therefore, as the speed increases and h decreases, P will also decrease.

This is the foundation for the *Pitot tube*, a simple device used to measure air speed in an aircraft (Figure 13.6). The Pitot tube extends out from the side of the aircraft and points into the flow. There is one small orifice at the end, where the speed of the gas relative to the tube is low, and several apertures along the tube, where the gas moves with approximately the air speed. The pressure difference between the end of the tube and the sides is measured using an instrument called a manometer and is then converted into an air speed using the formula $v = (2\Delta P/\rho)^{1/2}$ (which follows from the constancy of B). If $v \sim 100\text{m s}^{-1}$ and $\rho \sim 1\text{kg m}^{-3}$, then $\Delta P \sim 5000\text{N m}^{-3} \sim 0.05$ atmospheres.

In this book we shall meet many other applications of the Bernoulli Theorem for steady, ideal flows.

Bernoulli's Theorem for Irrotational flow of an isentropic fluid

An even more specialized type of flow is one where the vorticity vanishes and the entropy is constant *everywhere*. A flow in which $\boldsymbol{\omega} = 0$ is called an *irrotational* flow. (In Sec. 14.2, we shall learn that, if an incompressible flow initially is irrotational and it encounters no walls and experiences no significant viscous stresses, then it remains always irrotational.) Now, as the curl of the velocity field vanishes, we can follow the electrostatic precedent and introduce a *velocity potential* $\psi(\mathbf{x}, t)$ so that at any time,

$$\boxed{\mathbf{v} = \nabla\psi \quad \text{for an irrotational flow}} . \quad (13.53)$$

A flow in which the entropy is constant everywhere is called *isentropic* (Box 13.2). Now, the first law of thermodynamics [Eq. (3) of Box 13.2] implies that $\nabla h = T\nabla s + (1/\rho)\nabla P$. Therefore, in an isentropic flow, $\nabla P = \rho\nabla h$. Imposing these conditions on Eq. (13.48), we

obtain, for an isentropic, irrotational flow:

$$\nabla \left[\frac{\partial \psi}{\partial t} + B \right] = 0. \quad (13.54)$$

Thus: ***In an isentropic, irrotational flow of an ideal fluid, the quantity $\partial\psi/\partial t + B$ is constant everywhere.*** (If $\partial\psi/\partial t + B$ is a function of time, we can absorb that function into ψ without affecting \mathbf{v} , leaving it constant in time as well as in space.) Of course, if the flow is steady so $\partial(\text{everything})/\partial t = 0$, then B itself is constant. Note the important restriction that the vorticity in the flow must vanish.

13.5.5 Conservation of Energy

As well as imposing conservation of mass and momentum, we must also address energy conservation in its general form (by contrast with the specialized version of energy conservation inherent in Bernoulli's theorem for a stationary, ideal flow).

Energy conservation is needed, in general, for determining the temperature T of a fluid, which in turn is needed in computing the pressure $P(\rho, T)$. So far, in our treatment of fluid dynamics, we have finessed this issue by either postulating some relationship between the pressure P and the density ρ (e.g. the polytropic relation $P = K\rho^\gamma$), or by focusing on the flow of ideal fluids, where the absence of dissipation guarantees the entropy is constant moving with the flow, whence $P = P(\rho, s)$ with constant s . In more general situations, one cannot avoid confronting energy conservation. Moreover, even for ideal fluids, understanding how energy is conserved is often useful for gaining physical insight — as we have seen in our discussion of Bernoulli's theorem.

The most fundamental formulation of the law of energy conservation is Eq. (13.41): $\partial U/\partial t + \nabla \cdot \mathbf{F} = 0$. To explore its consequences for an ideal fluid, we must insert the appropriate ideal-fluid forms of the energy density U and energy flux \mathbf{F} .

When (for simplicity) the fluid is in an externally produced gravitational field Φ , its energy density is obviously

$$U = \rho \left(\frac{1}{2}v^2 + u + \Phi \right) \quad \text{for ideal fluid with external gravity} \quad (13.55)$$

Here the three terms are kinetic, internal, and gravitational. When the fluid participates in producing gravity and one includes the energy of the gravitational field itself, the energy density is a bit more subtle; see the track-two Box 13.4.

In an external field one might expect the energy flux to be $\mathbf{F} = U\mathbf{v}$, but this is not quite correct. Consider a bit of surface area dA orthogonal to the direction in which the fluid is moving, i.e., orthogonal to \mathbf{v} . The fluid element that crosses dA during time dt moves through a distance $dl = vdt$, and as it moves, the fluid behind this element exerts a force PdA on it. That force, acting through the distance dl , feeds an energy $dE = (PdA)dl = PvdAdt$ across dA ; the corresponding energy flux across dA has magnitude $dE/dAdt = Pv$ and obviously points in the \mathbf{v} direction, so it contributes $P\mathbf{v}$ to the energy flux \mathbf{F} . This contribution is

missing from our initial guess $\mathbf{F} = U\mathbf{v}$. We shall explore its importance at the end of this subsection. When it is added to our guess, we obtain for the total energy flux

$$\boxed{\mathbf{F} = \rho\mathbf{v} \left(\frac{1}{2}v^2 + h + \Phi \right)} \text{ for ideal fluid with external gravity} . \quad (13.56)$$

Here $h = u + P/\rho$ is the enthalpy per unit mass [cf. Box 13.2]. Inserting Eqs. (13.55) and (13.56) into the law of energy conservation (13.41), and requiring that the external gravity be static (time independent) so the work it does on the fluid is conservative, we get out the following ideal-fluid equation of energy balance:

$$\frac{\partial}{\partial t} \left[\rho \left(\frac{1}{2}v^2 + u + \Phi \right) \right] + \nabla \cdot \left[\rho\mathbf{v} \left(\frac{1}{2}v^2 + h + \Phi \right) \right] = 0 \text{ for ideal fluid \& static external gravity.} \quad (13.57)$$

When the gravitational field is dynamical and/or being generated by the fluid itself, we must use a more complete gravitational energy density and stress; see Box 13.4.

By combining this law of energy conservation with the corresponding laws of momentum and mass conservation (13.29) and (13.42), and using the first law of thermodynamics $dh = Tds + (1/\rho)dP$, we obtain the remarkable result that the entropy per unit mass is conserved moving with the fluid.

$$\boxed{\frac{ds}{dt} = 0 \text{ for an ideal fluid}} . \quad (13.58)$$

The same conclusion can be obtained when the gravitational field is dynamical and not external (cf. Box 13.4 and Ex. 13.13]), so no statement about gravity is included with this equation. This entropy conservation should not be surprising. If we put no dissipative processes into the energy density or energy flux or stress tensor, then we get no dissipation out. Moreover, the calculation that leads to Eq. (13.58) assures us that, *so long as we take full account of mass and momentum conservation, then the full and sole content of the law of energy conservation for an ideal fluid is $ds/dt = 0$.*

| Quantity | Density | Flux |
|----------|---------------------------------------|--|
| Mass | ρ | $\rho\mathbf{v}$ |
| Momentum | $\rho\mathbf{v}$ | $\mathbf{T} = P\mathbf{g} + \rho\mathbf{v} \otimes \mathbf{v}$ |
| Energy | $U = (\frac{1}{2}v^2 + u + \Phi)\rho$ | $\mathbf{F} = (\frac{1}{2}v^2 + h + \Phi)\rho\mathbf{v}$ |

Table 13.1: Densities and Fluxes of mass, momentum, and energy for an ideal fluid in an externally produced gravitational field.

Box 13.4
Self Gravity **T2**

In the text, we mostly treat the gravitational field as externally imposed and independent of the behavior of the fluid. This is usually a good approximation. However, it is inadequate for discussing the properties of planets and stars. It is easiest to discuss the modifications required by self-gravitational effects by amending the conservation laws.

As long as we work within the domain of Newtonian physics, the mass conservation equation (13.29) is unaffected. However, we included the gravitational force per unit volume $\rho\mathbf{g}$ as a source of momentum in the momentum conservation law (13.42). It would fit much more neatly into our formalism if we could express it as the divergence of a gravitational stress tensor \mathbf{T}_g . To see that this is indeed possible, use Poisson's equation $\nabla \cdot \mathbf{g} = -4\pi G\rho$ to write

$$\nabla \cdot \mathbf{T}_g = -\rho\mathbf{g} = \frac{(\nabla \cdot \mathbf{g})\mathbf{g}}{4\pi G} = \frac{\nabla \cdot [\mathbf{g} \otimes \mathbf{g} - \frac{1}{2}g^2\mathbf{g}]}{4\pi G},$$

so

$$\boxed{\mathbf{T}_g = \frac{\mathbf{g} \otimes \mathbf{g} - \frac{1}{2}g^2\mathbf{g}}{4\pi G}}. \quad (1)$$

Readers familiar with classical electromagnetic theory will notice an obvious and understandable similarity to the Maxwell stress tensor [Eq. (2.80)] whose divergence equals the Lorentz force density.

What of the gravitational momentum density? We expect that this can be related to the gravitational energy density using a Lorentz transformation. That is to say it is $O(v/c^2)$ times the gravitational energy density, where v is some characteristic speed. However, in the Newtonian approximation, the speed of light, c , is regarded as infinite and so we should expect the gravitational momentum density to be identically zero in Newtonian theory—and indeed it is. We therefore can write the full equation of motion (13.42), including gravity, as a conservation law

$$\frac{\partial(\rho\mathbf{v})}{\partial t} + \nabla \cdot \mathbf{T}_{\text{total}} = 0 \quad (2)$$

where $\mathbf{T}_{\text{total}}$ includes \mathbf{T}_g .

Turn to energy conservation: We have seen in the text that, in a constant, external gravitational field, the fluid's total energy density U and flux \mathbf{F} are given by Eqs. (13.55) and (13.56). In a general situation, we must add to these some field energy density and flux. On dimensional grounds, these must be $U_{\text{field}} \propto \mathbf{g}^2/G$ and $\mathbf{F}_{\text{field}} \propto \Phi_{,t}\mathbf{g}/G$ (where $\mathbf{g} = -\nabla\Phi$). The proportionality constants can be deduced by demanding that for an ideal fluid in the presence of gravity, the law of energy conservation when combined with mass conservation, momentum conservation, and the first law of thermodynamics, lead

Box 13.4, Continued T2

to $ds/dt = 0$ (no dissipation in, so no dissipation out); see Eq. (13.58) and associated discussion. The result [Ex. 13.13] is

$$U = \rho \left(\frac{1}{2}v^2 + u + \Phi \right) + \frac{g^2}{8\pi G}, \quad (3)$$

$$\mathbf{F} = \rho \mathbf{v} \left(\frac{1}{2}v^2 + h + \Phi \right) + \frac{1}{4\pi G} \frac{\partial \Phi}{\partial t} \mathbf{g}. \quad (4)$$

Actually, there is an ambiguity in how the gravitational energy is localized. This ambiguity arises physically from the fact that one can transform away the gravitational acceleration \mathbf{g} , at any point in space, by transforming to a reference frame that falls freely there. Correspondingly, it turns out, one can transform away the gravitational energy density at any desired point in space. This possibility is embodied mathematically in the possibility to add to the energy flux \mathbf{F} the time derivative of $\alpha \Phi \nabla \Phi / 4\pi G$ and add to the energy density U minus the divergence of this quantity (where α is an arbitrary constant), while preserving energy conservation $\partial U / \partial t + \nabla \cdot \mathbf{F} = 0$. Thus, the following choice of energy density and flux is just as good as Eqs. (2) and (3); both satisfy energy conservation:

$$U = \rho \left(\frac{1}{2}v^2 + u + \Phi \right) + \frac{g^2}{8\pi G} - \alpha \nabla \cdot \left(\frac{\Phi \nabla \Phi}{4\pi G} \right) = \rho \left[\frac{1}{2}v^2 + u + (1 - \alpha)\Phi \right] + (1 - 2\alpha) \frac{g^2}{8\pi G}, \quad (5)$$

$$\begin{aligned} \mathbf{F} &= \rho \mathbf{v} \left(\frac{1}{2}v^2 + h + \Phi \right) + \frac{1}{4\pi G} \frac{\partial \Phi}{\partial t} \mathbf{g} + \alpha \frac{\partial}{\partial t} \left(\frac{\Phi \nabla \Phi}{4\pi G} \right) \\ &= \rho \mathbf{v} \left(\frac{1}{2}v^2 + h + \Phi \right) + (1 - \alpha) \frac{1}{4\pi G} \frac{\partial \Phi}{\partial t} \mathbf{g} + \frac{\alpha}{4\pi G} \Phi \frac{\partial \mathbf{g}}{\partial t}. \end{aligned} \quad (6)$$

[Here we have used the gravitational field equation $\nabla^2 \Phi = 4\pi G \rho$ and $\mathbf{g} = -\nabla \Phi$.] Note that the choice $\alpha = 1/2$ puts all of the energy density into the $\rho \Phi$ term, while the choice $\alpha = 1$ puts all of the energy density into the field term g^2 . In Ex. 13.14 it is shown that the total gravitational energy of an isolated system is independent of the arbitrary parameter α , as it must be on physical grounds.

A full understanding of the nature and limitations of the concept of gravitational energy requires the general theory of relativity (Part VII). The relativistic analog of the arbitrariness of Newtonian energy localization is an arbitrariness in the gravitational “stress-energy pseudotensor”.

13.5.6 Joule-Kelvin Method of Cooling a Real Gas

Let us return to the contribution $P\mathbf{v}$ to the energy flux. A good illustration of the importance of this term is provided by the *Joule-Kelvin method* commonly used to cool gases (Fig. 13.7). In this method, gas is driven from a high-pressure chamber 1 through a nozzle or porous plug into a low-pressure chamber 2, where it can expand and cool. We can analyze the cooling using energy conservation, with the magnitude of the energy flux at the entrance to the nozzle written as $(\rho_1 u_1 + P_1)v_1$ (where we neglect the kinetic energy and gravitational terms as negligible). During a short time Δt , the energy that leaves the high-pressure chamber 1 is this energy flux into the nozzle times Δt times the nozzle entrance's area A_1 : $\Delta E_1 = (\rho_1 u_1 + P_1)v_1 \Delta t A_1 = H_1$; here H_1 is the enthalpy that the departing gas "sample" had when it was in chamber 1, occupying the volume $v_1 \Delta t A_1$. (Without the $P_1 v_1$ term in the flux, we would not get this result.) When this gas sample arrives in the low-pressure chamber 2, it is far from statistical (thermodynamic) equilibrium, but it soon equilibrates. After equilibration, it occupies some volume V_2 , it has done work $P_2 V_2$ on the gas in chamber 2 in order to open up that volume, and it possesses an internal energy $\rho_2 u_2 V_2$. Correspondingly, the total energy it has injected into chamber 2 is $\Delta E_2 = (\rho_2 u_2 + P_2)V_2 = H_2$ (its enthalpy); cf. the last part of Ex. 5.5. Energy conservation, $\Delta E_1 = \Delta E_2$, then guarantees that the enthalpy H_1 of this gas sample when it was in statistical equilibrium in chamber 1 is the same as its enthalpy H_2 when it has reached statistical equilibrium in chamber 2. Dividing by the mass of the sample, we see that *the enthalpy per unit mass, h , is the same in the two chambers: $h_1 = h_2$.*

Now, the temperature T of the gas, in statistical equilibrium, is some function of enthalpy and pressure, $T = T(h, P)$; so we can write the temperature drop between chamber 1 and chamber 2 as

$$\Delta T = \int_{P_1}^{P_2} \mu_{JK} dP, \quad (13.59)$$

where $\mu_{JK} \equiv (\partial T / \partial P)_h$ is the so-called Joule-Kelvin coefficient. A straightforward thermodynamic calculation yields the identity

$$\mu_{JK} \equiv \left(\frac{\partial T}{\partial P} \right)_h = -\frac{1}{\rho^2 c_p} \left(\frac{\partial(\rho T)}{\partial T} \right)_P. \quad (13.60)$$

The Joule-Kelvin coefficient of an ideal gas [one with $P = nk_B T = (\rho / \mu m_p) k_B T$] obviously vanishes. Therefore, the cooling must arise because of the attractive forces (van der

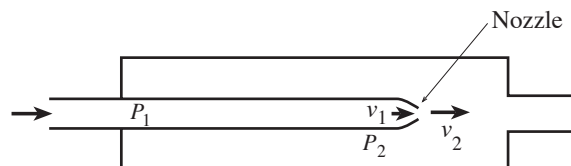

Fig. 13.7: Joule-Kelvin cooling of a gas. Gas flows steadily through a nozzle from a chamber at high pressure to one at low pressure. The flow proceeds at constant enthalpy. Work done against attractive intermolecular forces leads to cooling. The efficiency of cooling can be enhanced by exchanging heat between the two chambers. Gases can also be liquefied in this manner.

Waals forces; Sec. 5.3.2) between the molecules, which are absent in an ideal gas. When a real gas expands, work is done against these forces and the gas therefore cools.

13.6 Incompressible Flows

A common assumption made when discussing the fluid dynamics of highly subsonic flows is that the density is constant, i.e., that the fluid is *incompressible*. This is a natural approximation to make when dealing with a liquid like water, which has a very large bulk modulus. It is a bit of a surprise that it is also useful for flows of gases, which are far more compressible under static conditions.

To see its validity, suppose that we have a flow in which the characteristic length L over which the fluid variables P, ρ, v etc. vary is related to the characteristic timescale T over which they vary by $L \lesssim vT$. In this case, we can compare the magnitude of the various terms in the Euler equation (13.44) to obtain an estimate of the magnitude of the pressure variation:

$$\underbrace{\frac{\partial \mathbf{v}}{\partial t}}_{v/T} + \underbrace{(\mathbf{v} \cdot \nabla) \mathbf{v}}_{v^2/L} = - \underbrace{\frac{\nabla P}{\rho}}_{\delta P / \rho L} - \underbrace{\nabla \Phi}_{\delta \Phi / L}. \quad (13.61)$$

Multiplying through by L and using $L/T \lesssim v$ we obtain $\delta P / \rho \sim v^2 + |\delta \Phi|$. Now, the variation in pressure will be related to the variation in density by $\delta P \sim c^2 \delta \rho$, where $c = \sqrt{(\partial P / \partial \rho)_s}$ is the *sound* speed (Sec. 16.5), not light speed, and we drop constants of order unity in making these estimates. Inserting this into our expression for δP , we obtain the estimate for the fractional density fluctuation

$$\boxed{\frac{\delta \rho}{\rho} \sim \frac{v^2}{c^2} + \frac{\delta \Phi}{c^2}}. \quad (13.62)$$

Therefore, *if the fluid speeds are highly subsonic ($v \ll c$) and the gravitational potential does not vary greatly along flow lines, $|\delta \Phi| \ll c^2$, then we can ignore the density variations moving with the fluid when solving for the velocity field.* More specifically, since $\rho^{-1} d\rho/dt = \nabla \cdot \mathbf{v} = \theta$ [Eq. (13.31)], we can make the approximation

$$\nabla \cdot \mathbf{v} \simeq 0. \quad (13.63)$$

This argument breaks down when we are dealing with sound waves for which $L \sim cT$.

For air at atmospheric pressure, the speed of sound is $c \sim 300$ m/s, which is very fast compared to most flows speeds one encounters, so most flows are “incompressible”.

It should be emphasized, though, that the “incompressibility approximation” for the velocity field [Eq. (13.63)], does not imply that the density variation can be neglected in *all* other contexts. A particularly good example of this is provided by convection flows, which are driven by buoyancy as we shall discuss in Chap. 16.

EXERCISES

Exercise 13.7 *Problem: A Hole in My Bucket*

There's a hole in my bucket. How long will it take to empty? (Try an experiment and if the time does not agree with the estimate suggest why this is so.)

Exercise 13.8 *Problem: Rotating Planets, Stars and Disks*

Consider a stationary, axisymmetric planet star or disk differentially rotating under the action of a gravitational field. In other words, the motion is purely in the azimuthal direction.

- (a) Suppose that the fluid has a *barotropic* equation of state $P = P(\rho)$. Write down the equations of hydrostatic equilibrium including the centrifugal force in cylindrical polar coordinates. Hence show that the angular velocity must be constant on surfaces of constant cylindrical radius. This is called von Zeipel's theorem. (As an application, Jupiter is differentially rotating and therefore might be expected to have similar rotation periods at the same latitude in the north and the south. This is only roughly true, suggesting that the equation of state is not completely barotropic.)
- (b) Now suppose that the structure is such that the surfaces of constant entropy per unit mass and angular momentum per unit mass coincide. (This state of affairs can arise if slow convection is present.) Show that the Bernoulli function [Eq. (13.50)] is also constant on these surfaces. (Hint: Evaluate ∇B .)

Exercise 13.9 *Problem: Crocco's Theorem*

- (a) Consider steady flow of an ideal fluid. The Bernoulli function is conserved along streamlines. Show that the variation of B across streamlines is given by

$$\nabla B = T \nabla s + \mathbf{v} \times \boldsymbol{\omega} . \quad (13.64)$$

- (b) As an example, consider the air in a tornado. In the tornado's core, the velocity vanishes; and it also vanishes beyond the tornado's outer edge. Use Crocco's theorem to show that the pressure in the core is substantially different from that at the outer edge. Is it lower, or is it higher? How does this explain the ability of a tornado to make the walls of a house explode?

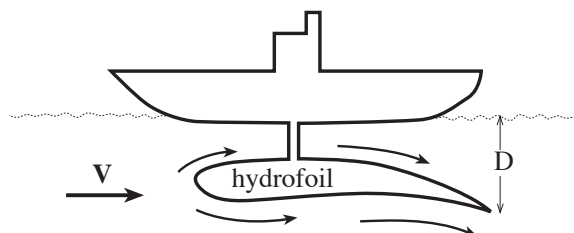

Fig. 13.8: Water flowing past a hydrofoil as seen in the hydrofoil's rest frame.

Exercise 13.10 *Problem: Cavitation*

A hydrofoil moves with speed V at a depth $D = 3\text{m}$ below the surface of a lake; see Figure 13.8. Estimate how fast V must be to make the water next to the hydrofoil boil. (This boiling, which is called *cavitation*, results from the pressure P trying to go negative.)

[Note: for a more accurate value of the speed V that triggers cavitation, one would have to compute the velocity field around the hydrofoil, e.g. using the method of Ex. 14.6 of the next chapter.]

Exercise 13.11 *Example: Collapse of a bubble*

Suppose that a spherical bubble has just been created in the water above the hydrofoil in the previous question. We will analyze its collapse, i.e. the decrease of its radius $R(t)$ from its value R_0 at creation. First show that the assumption of incompressibility implies that the radial velocity of the fluid at any radial location r can be written in the form $v = F(t)/r^2$. Then use the radial component of the Euler equation (13.44) to show that

$$\frac{1}{r^2} \frac{dF}{dt} + v \frac{\partial v}{\partial r} + \frac{1}{\rho} \frac{\partial P}{\partial r} = 0$$

and integrate this outward from the bubble surface at radius R to infinite radius to obtain

$$\frac{-1}{R} \frac{dF}{dt} + \frac{1}{2} v^2(R) = \frac{P_0}{\rho}$$

where P_0 is the ambient pressure. Hence show that the bubble surface moves with speed

$$v(R) = \left(\frac{2P_0}{3\rho} \right)^{1/2} \left[\left(\frac{R_0}{R} \right)^3 - 1 \right]^{1/2}$$

Suppose that bubbles formed near the pressure minimum on the surface of the hydrofoil are swept back onto a part of the surface where the pressure is much larger. By what factor must the bubbles collapse if they are to create stresses which inflict damage on the hydrofoil?

A modification of this solution is also important in interpreting the fascinating phenomenon of *Sonoluminescence* (Brenner, Hilgenfeldt & Lohse 2002). This arises when fluids are subjected to high frequency acoustic waves which create oscillating bubbles. The temperatures inside these bubbles can get so large that the air becomes ionized and radiates.

Exercise 13.12 *Derivation: Joule-Kelvin Coefficient*

Verify Eq. (13.60)

Exercise 13.13 **T2** *Derivation: No dissipation “in” means no dissipation “out”, and verification of the claimed gravitational energy density and flux*

Consider an ideal fluid interacting with a (possibly dynamical) gravitational field that the fluid itself generates via $\nabla^2 \Phi = 4\pi G\rho$. For this fluid, take the law of energy conservation $\partial U/\partial t + \nabla \cdot \mathbf{F} = 0$ and from it subtract the scalar product of \mathbf{v} with the law of momentum conservation, $\mathbf{v} \cdot [\partial(\rho\mathbf{v})/\partial t + \nabla \cdot \mathbf{T}]$; then simplify using the law of mass conservation and the first law of thermodynamics, to obtain $\rho ds/dt = 0$. In your computation, use for U and \mathbf{F}

the expressions given in Eqs. (3) and (4) of Box 13.4. This calculation tells us two things: (i) The law of energy conservation for an ideal fluid reduces simply to conservation of entropy moving with the fluid; we have put no dissipative physics into the fluxes of momentum and energy, so we get no dissipation out. (ii) The gravitational energy density and flux contained in Eqs. (3) and (4) of Box 13.4 must be correct, since they guarantee that gravity does not alter this “no dissipation in, no dissipation out” result.

Exercise 13.14 T2 *Example: Gravitational Energy*

Integrate the energy density U of Eq. (4) of Box 13.4 over the interior and surroundings of an isolated gravitating system to obtain the system’s total energy. Show that the gravitational contribution to this total energy (i) is independent of the arbitrariness (parameter α) in the energy’s localization, and (ii) can be written in the following forms:

$$\boxed{E_g = \int dV \frac{1}{2} \rho \Phi = -\frac{1}{8\pi G} \int dV g^2 = \frac{-G}{2} \int \int dV dV' \frac{\rho(\mathbf{x})\rho(\mathbf{x}')}{|\mathbf{x} - \mathbf{x}'|}}. \quad (13.65)$$

Interpret each of these expressions physically.

13.7 Viscous Flows with Heat Conduction

13.7.1 Decomposition of the Velocity Gradient

It is an observational fact that many fluids, when they flow, develop a *shear stress* (also called a *viscous stress*). Honey pouring off a spoon is a nice example. Most fluids, however, appear to flow quite freely; for example, a cup of tea appears to offer little resistance to stirring other than the inertia of the water. In such cases, it might be thought that viscous effects only produce a negligible correction to the flow’s details. However, this is not so. One of the main reasons is that most flows touch solid bodies at whose surfaces the velocity must vanish. This leads to the formation of boundary layers whose thickness and behavior are controlled by viscous forces. The boundary layers in turn can exert a controlling influence on the bulk flow (where the viscosity is negligible); for example, they can trigger the development of turbulence in the bulk flow — witness the stirred tea cup.

We must therefore augment our equations of fluid dynamics to include viscous stresses. Our formal development proceeds in parallel to that used in elasticity, with the velocity field $\mathbf{v} = d\boldsymbol{\xi}/dt$ replacing the displacement field $\boldsymbol{\xi}$. We decompose the velocity gradient tensor $\nabla\mathbf{v}$ into its irreducible tensorial parts: a *rate of expansion*, θ , a symmetric, trace-free *rate of shear* tensor $\boldsymbol{\sigma}$, and an antisymmetric *rate of rotation* tensor \mathbf{r} , i.e.

$$\boxed{\nabla\mathbf{v} = \frac{1}{3}\theta\mathbf{g} + \boldsymbol{\sigma} + \mathbf{r}}. \quad (13.66)$$

Note that we use lower case symbols to distinguish the fluid case from its elastic counterpart: $\theta = d\Theta/dt$, $\boldsymbol{\sigma} = d\boldsymbol{\Sigma}/dt$, $\mathbf{r} = d\mathbf{R}/dt$. Proceeding directly in parallel to the treatment in Chap. 11, we can invert Eq. (13.66) to obtain

$$\boxed{\theta = \nabla \cdot \mathbf{v}}, \quad (13.67a)$$

$$\boxed{\sigma_{ij} = \frac{1}{2}(v_{i;j} + v_{j;i}) - \frac{1}{3}\theta g_{ij}}, \quad (13.67b)$$

$$\boxed{r_{ij} = \frac{1}{2}(v_{i;j} - v_{j;i}) = -\frac{1}{2}\epsilon_{ijk}\omega^k}, \quad (13.67c)$$

where $\boldsymbol{\omega} = 2d\boldsymbol{\phi}/dt$ is the vorticity, which we introduced and discussed in Sec. 13.5.4 above.

13.7.2 Navier-Stokes Equation

Although, as we have emphasized, a fluid at rest does not exert a shear stress, and this distinguishes it from an elastic solid, a fluid in motion can resist shear in the velocity field. It has been found experimentally that in most fluids the magnitude of this shear stress is linearly related to the velocity gradient. This law, due to Hooke's contemporary, Isaac Newton, is the analogue of the linear relation between stress and strain that we used in our discussion of elasticity. Fluids that obey this law are known as *Newtonian*. (Some examples of non-Newtonian fluid behavior are shown in Figure 13.9.) In this book, we shall restrict ourselves to Newtonian fluids.

Fluids are usually isotropic. (Important exceptions include *smectic* liquid crystals.) In this book we shall restrict ourselves to isotropic fluids, where, by analogy with the theory

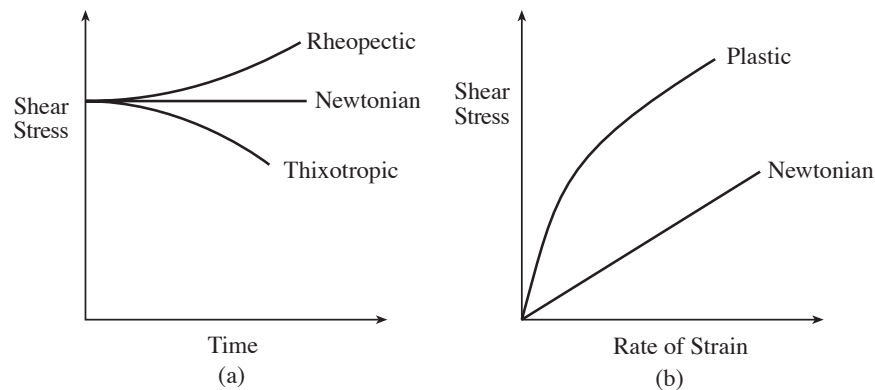

Fig. 13.9: Some examples of non-Newtonian behavior in fluids. (a) In a Newtonian fluid the shear stress is proportional to the rate of shear $\boldsymbol{\sigma}$ and does not vary with time when $\boldsymbol{\sigma}$ is constant. However, some substances, such as paint, flow more freely with time and are said to be *thixotropic*. Microscopically, what happens is that the long, thin paint molecules gradually become aligned with the flow, which reduces their resistance to shear. The opposite behaviour is exhibited by *rheopectic* substances. (b) An alternative type of non-Newtonian behavior is exhibited by various plastics, where a threshold stress is needed before flow will commence.

| Quantity | Kinematic viscosity ν (m^2s^{-1}) |
|-----------|---|
| Water | 10^{-6} |
| Air | 10^{-5} |
| Glycerine | 10^{-3} |
| Blood | 3×10^{-6} |

Table 13.2: Kinematic viscosity for common fluids.

of elasticity, we shall describe the linear relation between stress and rate of strain using two constants called the coefficients of *bulk* and *shear* viscosity and denoted ζ and η respectively. We write the viscous contribution to the stress tensor as

$$\mathbf{T}_{\text{vis}} = -\zeta\theta\mathbf{g} - 2\eta\boldsymbol{\sigma}, \quad (13.68)$$

by analogy to Eq. (11.18).

If we include this viscous contribution in the stress tensor, then the law of momentum conservation $\partial(\rho\mathbf{v})/\partial t + \nabla \cdot \mathbf{T} = \rho\mathbf{g}$ gives the following modification of Euler's equation (13.44):

$$\rho \frac{d\mathbf{v}}{dt} = -\nabla P + \rho\mathbf{g} + \nabla(\zeta\theta) + 2\nabla \cdot (\eta\boldsymbol{\sigma}) \quad (13.69)$$

This is called the *Navier-Stokes equation*, and the last two terms are the viscous force density.

For incompressible flows (e.g., when the flow is highly subsonic; Sec. 13.6), θ can be approximated as zero so the bulk viscosity can be ignored. The viscosity coefficient η generally varies in space far more slowly than the shear $\boldsymbol{\sigma}$, and so can be taken outside the divergence. In this case, Eq. (13.69) simplifies to

$$\frac{d\mathbf{v}}{dt} = -\frac{\nabla P}{\rho} + \mathbf{g} + \nu \nabla^2 \mathbf{v}, \quad (13.70)$$

where

$$\nu \equiv \frac{\eta}{\rho} \quad (13.71)$$

is known as the *kinematic viscosity*, by contrast with η which is often called the *dynamic viscosity*. Equation (13.71) is the commonly quoted form of the Navier-Stokes equation. Values of the kinematic viscosity for common fluids are given in Table 13.2.

13.7.3 Energy conservation and entropy production

The viscous stress tensor represents an additional momentum flux which can do work on the fluid at a rate $\mathbf{T}_{\text{vis}} \cdot \mathbf{v}$ per unit area. There is therefore a contribution

$$\mathbf{F}_{\text{vis}} = \mathbf{T}_{\text{vis}} \cdot \mathbf{v} \quad (13.72)$$

to the energy flux, just like the term $P\mathbf{v}$ appearing (as part of the $\rho\mathbf{v}h$) in Eq. (13.56). Diffusive heat flow (thermal conductivity) can also contribute to the energy flux; its contribution is [Eq. (3.67b)]

$$\boxed{\mathbf{F}_{\text{cond}} = -\kappa\nabla T}, \quad (13.73)$$

where κ is the coefficient of thermal conductivity. The molecules or particles that produce the viscosity and the heat flow also carry energy, but their energy density is included already in u , the total internal energy per unit mass. The total energy flux, including these contributions, is shown in Table 13.3, along with the energy density and the density and flux of momentum.

We see most clearly the influence of the dissipative viscous forces and heat conduction on energy conservation by inserting the energy density and flux from Table 13.3 into the law of energy conservation $\partial U/\partial t + \nabla \cdot \mathbf{F} = 0$, subtracting $\mathbf{v} \cdot [\partial(\rho\mathbf{v})/\partial t + \nabla \cdot \mathbf{T} = 0]$ (\mathbf{v} dotted into momentum conservation), and simplifying using mass conservation and the first law of thermodynamics. The result (Ex. 13.17) is the following equation for the evolution of entropy:

$$\boxed{T \left[\rho \left(\frac{ds}{dt} \right) + \nabla \cdot \left(\frac{\mathbf{F}_{\text{cond}}}{T} \right) \right] = \zeta\theta^2 + 2\eta\boldsymbol{\sigma} : \boldsymbol{\sigma} + \frac{\kappa}{T}(\nabla T)^2}. \quad (13.74)$$

The term in square brackets on the left side represents an increase of entropy per unit volume moving with the fluid due to dissipation (the total increase minus that due to heat flowing conductively into a unit volume); multiplied by T this is the dissipative increase in entropy density. This increase of random, thermal energy is being produced, on the right side, by viscous heating (first two terms), and by the flow of heat $\mathbf{F}_{\text{cond}} = -\kappa\nabla T$ down a temperature gradient $-\nabla T$ (third term).

The dissipation equation (13.74) is the full content of the law of energy conservation for a dissipative fluid, when one takes account of mass conservation, momentum conservation, and the first law of thermodynamics.

Remarkably, we can combine this Lagrangian rate of viscous dissipation with the equation of mass conservation (13.29) to obtain an Eulerian differential equation for the entropy increase:

$$\boxed{\frac{\partial(\rho s)}{\partial t} + \nabla \cdot (\rho s\mathbf{v} - \kappa\nabla \ln T) = \frac{1}{T} \left(\zeta\theta^2 + 2\eta\boldsymbol{\sigma} : \boldsymbol{\sigma} + \frac{\kappa}{T}(\nabla T)^2 \right)}. \quad (13.75)$$

The left hand side of this equation describes the rate of change of entropy density plus the divergence of entropy flux. The right hand side is therefore the rate of production of entropy

| Quantity | Density | Flux |
|----------|---------------------------------------|---|
| Mass | ρ | $\rho\mathbf{v}$ |
| Momentum | $\rho\mathbf{v}$ | $\mathbf{T} = \rho\mathbf{v} \otimes \mathbf{v} + P\mathbf{g} + \frac{g^2}{4\pi G} - \zeta\theta\mathbf{g} - 2\eta\boldsymbol{\sigma}$ |
| Energy | $U = (\frac{1}{2}v^2 + u + \Phi)\rho$ | $\mathbf{F} = (\frac{1}{2}v^2 + h + \Phi)\rho\mathbf{v} - \zeta\theta\mathbf{v} - 2\eta\boldsymbol{\sigma} \cdot \mathbf{v} - \kappa\nabla T$ |

Table 13.3: Densities and Fluxes of mass, momentum, and energy for a dissipative fluid in an externally produced gravitational field. For self-gravitating systems see Box 13.4.

per unit volume. Invoking the second law of thermodynamics, this must be positive definite. Therefore the two coefficients of viscosity, like the bulk and shear moduli, must be positive, as must the coefficient of thermal conductivity κ (heat must flow from hotter regions to cooler regions).

In most laboratory and geophysical flows, thermal conductivity is unimportant, so we shall largely ignore it until Chap. 16.

13.7.4 Molecular Origin of Viscosity

Microscopically, we can distinguish gases from liquids. In a gas, a molecule of mass m travels a distance of order its *mean free path* λ before it collides. If there is a shear in the fluid (Fig. 13.10), then the molecule, traveling in the y direction, on average will transfer an x momentum $\sim -m\lambda\sigma_{xy}$ between collision points. If there are n molecules per unit volume traveling with mean thermal speeds v_{th} , then the transferred momentum crossing a unit area in unit time is $T_{xy} \sim -nmv_{\text{th}}\lambda\sigma_{xy}$, from which, by comparison with Eq. (13.68), we can extract an estimate of the coefficient of shear viscosity

$$\eta \simeq \frac{1}{3}\rho v_{\text{th}}\lambda. \quad (13.76)$$

Here the numerical coefficient of $1/3$ (which arises from averaging over molecular directions and speeds) has been inserted to agree with a proper kinetic-theory calculation; see Ex. 3.18 in Chap. 3. Note from Eq. (13.76) that in a gas, where the mean thermal kinetic energy $\frac{3}{2}kT$ is $\sim m\bar{v}_{\text{th}}^2$, the coefficient of viscosity will increase with temperature as, $\nu \propto T^{1/2}$.

In a liquid, where the molecules are less mobile, it is the close intermolecular attraction that produces the shear stress. The ability of molecules to slide past one another increases rapidly with their thermal activation, causing typical liquid viscosity coefficients to fall dramatically with temperature.

13.7.5 Reynolds' Number

The kinematic viscosity ν has dimensions $[L]^2[T]^{-1}$. This suggests that we quantify the importance of viscosity by comparing ν with the product of a characteristic flow velocity V

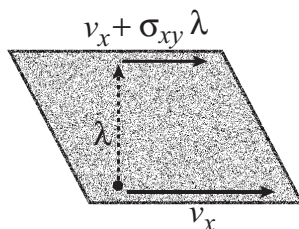

Fig. 13.10: Molecular origin of viscosity in a gas: A molecule travels a distance λ in the y direction between collisions. Its mean x -velocity at its point of origin is that of the fluid there, v_x , which differs from the mean fluid velocity at its next collision by $-\sigma_{xy}\lambda$. As a result, it transports a momentum $-m\sigma_{xy}\lambda$ to the location of its next collision.

and a characteristic length L . The dimensionless combination

$$\boxed{\text{Re} = \frac{LV}{\nu}} \quad (13.77)$$

is known as the *Reynolds' number*, and is the first of many dimensionless numbers we shall encounter in our study of fluid mechanics. Flows with Reynolds number much less than unity – such as the tragic Boston molasses tank explosion in 1919 – are dominated by viscosity. Large Reynolds' number flows can also be controlled by viscosity (as we shall see in later chapters), especially when the viscosity acts near boundaries — despite the fact that the viscous stresses are negligible over most of the flow's volume.

13.7.6 Pipe Flow

Let us now consider a simple example of viscous stresses at work, namely the flow of blood down an artery. We shall model the artery as a cylindrical pipe of radius R , down which the blood is forced by a pressure gradient. This is an example of what is called *pipe flow*.

Because gravity is unimportant and the flow is time independent, the law of momentum conservation $\partial(\rho\mathbf{v})/\partial t + \nabla \cdot \mathbf{T} = \rho\mathbf{g}$ [Eq. (13.42)] reduces to the vanishing divergence of the total stress tensor:

$$\nabla \cdot (\rho\mathbf{v} \otimes \mathbf{v} + P\mathbf{g} - 2\eta\boldsymbol{\sigma}) = 0 \quad (13.78)$$

[Eq. (13.43) augmented by the shear viscous stress (13.68)]. Now, in most instances of pipe flow, including blood in an artery, $\rho v^2 \ll \Delta P =$ (the pressure difference between the pipe's two ends), so we can neglect the first term in Eq. (13.78). We assume that the flow is *laminar* (smooth, as is usually the case for blood in arteries — fortunately!), so \mathbf{v} points solely along the z direction and is only a function of cylindrical radius ϖ . This is, in fact, a very important restriction. As we shall discuss in detail in Chap. 15, it often fails (e.g. in crude oil pipelines) because the flow becomes *turbulent*, and this has a major impact.

As the density is effectively constant (this flow is very subsonic with negligible gravity), and mass is conserved, the velocity cannot change along the pipe, whence $\mathbf{v} = v(\varpi)\mathbf{e}_z$. Therefore the only non-vanishing component of the shear tensor is the ϖz component. Re-expressing Eq. (13.78) in cylindrical coordinates, and inferring from it that the pressure is a function of z only and not of ϖ , we obtain

$$\frac{1}{\varpi} \frac{d}{d\varpi} \left(\varpi \eta \frac{dv}{d\varpi} \right) = \frac{dP}{dz}, \quad (13.79)$$

where dP/dz (which is negative) is the pressure gradient along the pipe. This differential equation must be solved subject to the boundary conditions that the velocity gradient vanish at the center of the pipe and that the velocity vanish at its walls. The solution is

$$v(\varpi) = -\frac{dP}{dz} \frac{R^2 - \varpi^2}{4\eta} \quad (13.80)$$

Using this velocity field, we can now evaluate the pipe's total *discharge*, i.e. the rate of flow of mass down the pipe:

$$\frac{dm}{dt} = \int_0^R \rho v 2\pi \varpi d\varpi = -\frac{dP}{dz} \frac{\pi \rho R^4}{8\eta} \quad (13.81)$$

This relation is known as *Poiseuille's law*.

Now let us apply this to blood. Consider an artery of radius $R = 1\text{mm}$. An estimate of the pressure gradient may be obtained from the difference between the diastolic and systolic pressure measured by a doctor ($\sim 40\text{mm}$ of mercury $\sim 5 \times 10^3\text{N m}^{-2}$ in a healthy adult) and dividing by the length of the artery, $\sim 1\text{m}$. The kinematic viscosity is $\eta/\rho = \nu = 3 \times 10^{-6}\text{m}^2\text{s}^{-1}$ from Table 13.2. The rate of blood flow is thus $\sim 3 \times 10^{-4}\text{kg s}^{-1}$ or $\sim 3 \times 10^{-7}\text{m}^3\text{s}^{-1}$. Now, supposing there are ten such arteries of this size and length, the total blood flow from the heart into the body will be $\sim 3 \times 10^{-6}\text{m}^3\text{s}^{-1}$.

Actually, the heart of a healthy adult pumps the full complement of blood ~ 5 litres or $\sim 5 \times 10^{-3}\text{m}^3$ every minute at a mean rate of $\sim 10^{-4}\text{m}^3\text{s}^{-1}$, which is about thirty times faster than our estimate. The main reason for this large discrepancy is that we have assumed in our calculation that the walls of an artery are rigid. They are not. They are quite elastic and are able to contract and expand in a wave-like manner so as to boost the blood flow considerably.

Note that the Poiseuille formula (13.81) is very sensitive to the radius of the pipe, $dm/dt \propto R^4$, so a factor two increase in radius increases the flow of blood by sixteen. Therefore, both hardening and thinning of the arteries will strongly inhibit the flow of blood, as will partial blockages, which trigger turbulence. Eat salads!

EXERCISES

Exercise 13.15 *** Example: Kinematic interpretation of Vorticity*

Consider a velocity field with non-vanishing curl. Define a locally orthonormal basis at a point in the velocity field so that one basis vector, \mathbf{e}_x is parallel to the vorticity. Now imagine the remaining two basis vectors as being frozen into the fluid. Show that they will both rotate about the axis defined by \mathbf{e}_x and that the vorticity will be the sum of their angular velocities (i.e. twice the average of their angular velocities). ex13n:VorticityLegs

Exercise 13.16 *Problem: Mean free path*

Estimate the collision mean free path of the air molecules around you. Hence verify the estimate for the kinematic viscosity of air given in Table 13.2.

Exercise 13.17 *Derivation: Entropy Increase*

- (a) Derive the Lagrangian equation (13.74) for the rate of increase of entropy in a dissipative fluid by the steps in the sentence preceding that equation. [Hints: If you have already done the analogous problem, Ex. 13.13, for an ideal fluid, then you need only compute the new terms that arise from the dissipative momentum flux $\mathbf{T}_{\text{vis}} = -\zeta\theta\mathbf{g} - 2\eta\boldsymbol{\sigma}$ and dissipative energy fluxes $\mathbf{F}_{\text{vis}} = \mathbf{T}_{\text{vis}} \cdot \mathbf{v}$ and $\mathbf{F}_{\text{cond}} = -\kappa\nabla T$. The sum of these new contributions, when you subtract $\mathbf{v} \cdot (\nabla \cdot \mathbf{T}_{\text{vis}})$ (momentum conservation) from energy conservation, is $\nabla \cdot \mathbf{F}_{\text{cond}} + \nabla \cdot (\mathbf{T}_{\text{vis}} \cdot \mathbf{v}) - \mathbf{v} \cdot (\nabla \cdot \mathbf{T}_{\text{vis}})$; and this must be added to the left side of the result $\rho T ds/dt = 0$, Eq. (13.58), for an ideal fluid. In doing the algebra, it may be useful to decompose the gradient of the velocity into its irreducible tensorial parts, Eq. (13.66).]

- (b) From the Lagrangian equation of entropy increase (13.74) derive the corresponding Eulerian equation (13.75).

Exercise 13.18 *Problem: Steady Flow Between Two Plates*

A viscous fluid flows steadily (no time dependence) between two plates that are parallel to the $x \wedge z$ plane and are separated by a distance a . Derive the flow's velocity field, and from it show that the mass flow rate (the discharge) per unit width of the plates is

$$\frac{dm}{dt dx} = -\frac{dP}{dz} \frac{\rho a^3}{12\eta}. \quad (13.82)$$

Here dP/dz (which is negative) is the pressure gradient along the direction of flow.

13.8 T2 Relativistic Dynamics of an Ideal Fluid

When a fluid's speed $v = |\mathbf{v}|$ becomes comparable to the speed of light $c = 1$, or P/ρ or u become of order unity, Newtonian fluid mechanics breaks down and must be replaced by a relativistic treatment. In this section, we shall briefly sketch the resulting laws of relativistic fluid dynamics for an ideal (perfect) fluid. For the extension to a fluid with dissipation (viscosity and heat conductivity), see, e.g., Ex. 22.7 of Misner, Thorne and Wheeler (1973).

Our treatment takes off from the brief description of an ideal, relativistic fluid in Secs. 2.12.3 and 2.13.3 of Chap. 2.

13.8.1 T2 Stress-Energy Tensor and Equations of Relativistic Fluid Mechanics

For relativistic fluids, we use ρ to denote the total density of mass-energy (including rest mass and internal energy), in the fluid's local rest frame; it is sometimes written as

$$\rho = \rho_o(1 + u), \quad \text{where } \rho_o = \bar{m}_B n \quad (13.83)$$

is the density of rest mass, \bar{m}_B is some standard mean rest mass per baryon, n is the number density of baryons, ρ_o is the density of rest mass, and u is the specific internal energy (Sec. 2.12.3 of Chap. 2).

The stress-energy tensor $T^{\alpha\beta}$ for a relativistic, ideal fluid takes the form [Eq. (2.74b)]

$$T^{\alpha\beta} = (\rho + P)u^\alpha u^\beta + P g^{\alpha\beta}, \quad (13.84)$$

where P is the fluid's pressure (as measured in its local rest frame), u^α is its 4-velocity, and $g^{\alpha\beta}$ is the spacetime metric. In the fluid's local rest frame, where $u^0 = 1$ and $u^j = 0$, the components of this stress-energy tensor are, of course, $T^{00} = \rho$, $T^{j0} = T^{0j} = 0$, $T^{jk} = P g^{jk} = P \delta^{jk}$.

The dynamics of our relativistic, ideal fluid are governed by five equations: *First Equation*: the law of *rest-mass conservation*, $(\rho_o u^\alpha)_{;\alpha} = 0$, can be rewritten in the forms [Eqs. (2.64) and (2.65) of Ex. 2.24]

$$\frac{d\rho_o}{d\tau} = -\rho_o \vec{\nabla} \cdot \vec{u}, \quad \text{i.e.} \quad \frac{d(\rho_o V)}{d\tau} = 0, \quad (13.85a)$$

where $d/d\tau = \vec{u} \cdot \vec{\nabla}$ is the derivative with respect to proper time moving with the fluid, $\vec{\nabla} \cdot \vec{u} = (1/V)(dV/d\tau)$ is the divergence of the fluid's 4-velocity, and V is the volume of a fluid element. *Second and Third Equations: Energy conservation*, in the form of the vanishing divergence of the stress-energy tensor projected onto the fluid 4-velocity, $u_\alpha T^{\alpha\beta}{}_{;\beta} = 0$, when combined with the law of mass conservation, reduces to the first law of thermodynamics without dissipation [Eq. (2.76b)] because our fluid is dissipation-free:

$$\frac{d\rho}{d\tau} = -(\rho + P)\vec{\nabla} \cdot \vec{u}, \quad \text{i.e.} \quad \frac{d(\rho V)}{d\tau} = -P\frac{dV}{d\tau}, \quad \text{whence,} \quad \frac{ds}{d\tau} = 0. \quad (13.85b)$$

Here s is the entropy per unit rest mass. There are actually two equations here: the constancy of s moving with the fluid, and the evolution equation for ρ . *Fourth Equation: Momentum conservation*, obtained by projecting the vanishing divergence of the stress-energy tensor orthogonal to the fluid's 4-velocity, $P_{\alpha\mu} T^{\mu\nu}{}_{;\nu} = 0$, reduces to [Eq. (2.76c)]

$$(\rho + P)\frac{du^\alpha}{d\tau} = -P^{\alpha\mu} P_{;\mu} = 0, \quad \text{where} \quad P^{\alpha\mu} = g^{\alpha\mu} + u^\alpha u^\mu. \quad (13.85c)$$

This is the *relativistic Euler equation*, and $P^{\alpha\mu}$ (not to be confused with the fluid pressure P or its gradient $P_{;\mu}$) is the tensor that projects orthogonal to \vec{u} . Note that the inertial mass per unit volume is $\rho + P$ (Ex. 2.27), and that the pressure gradient produces a force that is orthogonal to \vec{u} . *Fifth Equation*: An *equation of state* must be provided, e.g. in the form

$$P = P(\rho_o, s). \quad (13.85d)$$

Equations (13.85) are four independent scalar equations and one vector equation for the four scalars ρ_o, ρ, P, s and one vector \vec{u} .

As an example of an equation of state, one that we shall use below, consider a fluid so hot that its pressure and energy density are dominated by thermal motions of relativistic particles (photons, electron-positron pairs, ...), so $P = \rho/3$ [Eq. (3.51a)]. Then from the first law of thermodynamics for a fluid element $d(\rho V) = -P dV$ and the law of rest-mass conservation $d(\rho_o V) = 0$, one can deduce the relativistic polytropic equation of state

$$P = \frac{1}{3}\rho = K(s)\rho_o^{4/3}. \quad (13.86)$$

13.8.2 T2 Relativistic Bernoulli Equation and Ultrarelativistic Astrophysical Jets

When the relativistic flow is steady (independent of time t in some chosen inertial frame), the law of energy conservation in that frame, $T^{0\mu}{}_{;\mu} = 0$ and the law of mass conservation,

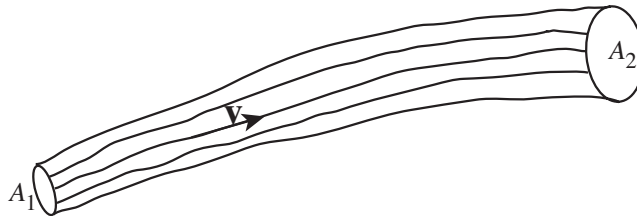

Fig. 13.11: A tube generated by streamlines for a stationary flow. The tube ends are orthogonal to the streamlines and have areas A_1 and A_2 .

$(\rho_o u^\mu)_{;\mu} = 0$ together imply that a certain relativistic Bernoulli function B is conserved along flow lines, specifically:

$$\frac{dB}{d\tau} = \gamma v_j \frac{\partial B}{\partial x^j} = 0, \quad \text{where } B = \frac{(\rho + P)\gamma}{\rho_o}. \quad (13.87)$$

Here $\gamma = u^0 = 1/\sqrt{1 - \mathbf{v}^2}$. A direct proof is left as an exercise for the reader, Ex. 13.19. The following more indirect, geometric proof provides useful insight:

Consider a narrow tube in space, whose walls are generated by streamlines (i.e., are tangent to the velocity field \mathbf{v}); Fig. 13.11. Denote the tube's interior by \mathcal{V} and its boundary by $\partial\mathcal{V}$. Because the flow is steady, the law of mass conservation $(\rho_o u^\alpha)_{;\alpha} = 0$ reduces to the vanishing spatial divergence $(\rho_o u^j)_{;j} = (\rho_o \gamma v^j)_{;j} = 0$. Integrate this equation over the tube's interior and apply Gauss's law to obtain $\int_{\partial\mathcal{V}} \rho_o \gamma v^j d\Sigma_j = 0$. Because the walls of the tube are parallel to v^j , they give zero contribution. The contribution from the ends give $(\rho_o \gamma v)_2 A_2 - (\rho_o \gamma v)_1 A_1 = 0$. In other words: **The product $\rho_o \gamma v A$ is constant along the stream tube.**

Similarly, for our steady flow, the law of energy conservation $T^{0\alpha}_{;\alpha} = 0$ reduces to the vanishing spatial divergence $T^{0j}_{;j} = [(\rho + P)\gamma^2 v^j]_{;j} = 0$, which, when integrated over the tube's interior and converted to a surface integral using Gauss's theorem, implies that: **The product $(\rho + P)\gamma^2 v A$ is constant along the stream tube.**

The ratio of these two constants, $(\rho + P)\gamma/\rho_o = B$ must also be constant along the narrow tube, or (since B is independent of the tube area), it must be constant along a streamline, which is Bernoulli's theorem.

An important venue for relativistic fluid mechanics is the narrow relativistic jets that emerge from some galactic nuclei. The flow velocities in some of these jets are measured to be so close to the speed of light, that $\gamma \gg 1$. Assuming the gas pressure P and mass-energy density ρ are dominated by relativistic particles, so the equation of state is $P = \rho/3 = K\rho_o^{4/3}$, we can use the above bold-faced conservation laws to learn how ρ , P , and γ evolve along such a jet:

From the relativistic Bernoulli theorem (the ratio of the two constants) and the equation of state, we deduce that $\gamma \propto B\rho_o/(\rho + P) \propto \rho_o/\rho_o^{4/3} \propto \rho_o^{-1/3} \propto \rho^{-1/4}$. This describes a conversion of the jet's internal mass-energy ($\sim \rho$) into bulk flow energy ($\sim \gamma$): As the internal energy (the energy of random thermal motions of the jet's particles) goes down, the bulk flow energy (energy of organized flow) goes up.

This energy exchange is actually driven by changes in the jet's cross sectional area, which (in some jets) is controlled by competition between the inward pressure of surrounding, little-moving gas and outward pressure from the jet itself. Since $\rho_o \gamma v A \simeq \rho_o \gamma A$ is constant along the jet, we have $A \propto 1/(\rho_o \gamma) \propto \gamma^2 \propto \rho^{-1/2}$. Therefore, as the jet's cross sectional area A increases, internal energy $\rho \propto 1/A^2$ goes down and the energy of bulk flow, $\gamma \propto A^{1/2}$ goes up. When γ drops to near unity, this transformation of internal energy into bulk-flow energy dies out.

How the jet can get started in the first place we shall explore in Chaps. 17 and 25.

13.8.3 T2 Nonrelativistic Limit of the Stress-Energy Tensor

It is instructive to evaluate the nonrelativistic limit of the perfect-fluid stress-energy tensor $T^{\alpha\beta} = (\rho + P)u^\alpha u^\beta + P g^{\alpha\beta}$, and verify that it has the form we deduced in our study of nonrelativistic fluid mechanics: Table 13.1 on page 27 with vanishing gravitational potential $\Phi = 0$.

In the nonrelativistic limit, the fluid is nearly at rest in the chosen Lorentz reference frame. It moves with ordinary velocity $\mathbf{v} = d\mathbf{x}/dt$ that is small compared to the speed of light, so the temporal part of its 4-velocity $u^0 = 1/\sqrt{1-v^2}$ and spatial part $\mathbf{u} = u^0 \mathbf{v}$ can be approximated as

$$u^0 \simeq 1 + \frac{1}{2}v^2, \quad \mathbf{u} \simeq \left(1 + \frac{1}{2}v^2\right) \mathbf{v}. \quad (13.88)$$

We shall write $\rho = \rho_o(1+u)$ [Eq. (13.83)], where u is the specific internal energy (not to be confused with the fluid 4-velocity \vec{u} or its spatial part \mathbf{u}). Now, in our chosen Lorentz frame the volume of each fluid element is Lorentz contracted by the factor $\sqrt{1-v^2}$ and therefore the rest mass density is increased from ρ_o to $\rho_o/\sqrt{1-v^2} = \rho_o u^0$; and correspondingly the rest-mass flux is $\rho_o u^0 \mathbf{v} = \rho_o \mathbf{u}$ [Eq. 2.62], and the law of rest-mass conservation is $\partial(\rho_o u^0)/\partial t + \partial(\rho_o u^j)/\partial x^j = 0$. When taking the Newtonian limit, we should identify the Newtonian mass ρ_N with the low-velocity limit of this rest-mass density:

$$\rho_N = \rho_o u^0 \simeq \rho_o \left(1 + \frac{1}{2}v^2\right). \quad (13.89)$$

The nonrelativistic limit regards the specific internal energy u , the kinetic energy per unit mass $\frac{1}{2}v^2$, and the ratio of pressure to rest-mass density P/ρ_o as of the same order of smallness

$$u \sim \frac{1}{2}v^2 \sim \frac{P}{\rho_o} \ll 1, \quad (13.90)$$

and it expresses the momentum density T^{j0} accurate to first order in $v \equiv |\mathbf{v}|$, the momentum flux (stress) T^{jk} accurate to second order in v , the energy density T^{00} accurate to second order in v , and the energy flux T^{0j} accurate to third order in v . To these accuracies, the perfect-fluid stress-energy tensor (13.84) takes the following form:

$$\begin{aligned} T^{j0} &= \rho_N v^j, & T^{jk} &= P g^{jk} + \rho_N v^j v^k, \\ T^{00} &= \rho_N + \frac{1}{2}\rho_N v^2 + \rho_N u, & T^{0j} &= \rho_N v^j + \left(\frac{1}{2}v^2 + u + \frac{P}{\rho_N}\right) \rho_N v^j; \end{aligned} \quad (13.91)$$

see Ex. 13.20(c). These are precisely the same as the nonrelativistic momentum density, momentum flux, energy density, and energy flux in Table 13.1, aside from the notational change from there to here $\rho \rightarrow \rho_N$, and aside from including the rest mass-energy $\rho_N = \rho_N c^2$ in T_{00} here but not there, and including the rest-mass-energy flux $\rho_N v^j$ in T^{0j} here but not there.

EXERCISES

Exercise 13.19 T2 *Derivation: Relativistic Bernoulli Theorem*

By manipulating the differential forms of the law of rest-mass conservation and the law of energy conservation, derive the constancy of $B = (\rho + P)\gamma/\rho_o$ along flow lines, Eq. (13.87).

Exercise 13.20 T2 *Derivation: Nonrelativistic Limit of Perfect-Fluid Stress-Energy Tensor*

- (a) Show that in the nonrelativistic limit, the components of the perfect-fluid stress-energy tensor (13.84) take on the forms (13.91), and verify that these agree with the densities and fluxes of energy and momentum that are used in nonrelativistic fluid mechanics (Table 13.1 on page 27).
- (b) Show that it is the contribution of the pressure P to the relativistic density of inertial mass that causes the term $(P/\rho_N)\rho_N \mathbf{v} = P\mathbf{v}$ to appear in the nonrelativistic energy flux.

Bibliographic Note

There are many good texts on fluid mechanics, most directed toward an engineering or applied mathematics audience. Among those we find useful are Acheson (1990) at an elementary level, and Batchelor (1970) and Lighthill (1986) at a more advanced level. Landau and Lifshitz (1959) as always is terse, but good for physicists who already have some knowledge of the subject. Tritton (1977) takes an especially physical approach to the subject, with lots of useful diagrams and photographs of fluid flows.

Physical intuition is very important in fluid mechanics, and is best developed with the aid of visualizations — both movies and photographs. In recent years many visualizations have been made available on the web. For a catalog, see University of Iowa Fluids Laboratory (1999). Movies that we have found especially useful are those of Hunter Rouse (1965) and the National Committee for Fluid Mechanics Films (1963).

Bibliography

- Acheson, D. J. 1990. *Elementary Fluid Dynamics*, Oxford: Clarendon Press.
- Batchelor, G. K. 1970. *An Introduction to Fluid Dynamics*, Cambridge: Cambridge University Press.
- Brenner, M. P., Hilgenfeldt, S. & Lohse, D. 2002 Rev. Mod. Phys. 74 425
- Chandrasekhar, S. 1939. *Stellar Structure*, Chicago: University of Chicago Press; reprinted by Dover Publications.
- Landau, L. D. and Lifshitz, E. M. 1959. *Fluid Mechanics*, Oxford: Pergamon.
- Lighthill, J. 1986. *An Informal Introduction to Theoretical Fluid Mechanics*, Oxford: Oxford University Press.
- Misner, C.W., Thorne, K.S., and Wheeler, J.A. 1973. *Gravitation*, San Francisco: Freeman.
- National Committee for Fluid Mechanics Films, ca. 1963. *Fluid Mechanics Films*. Available at <http://web.mit.edu/fluids/www/Shapiro/ncfmf.html> .
- Reif, F. 1959. *Fundamentals of Statistical and Thermal Physics*, New York: McGraw-Hill.
- Rouse, H. ca. 1965. *Fluid Mechanics Movies*. Available at <http://users.rowan.edu/~orlins/fm/movies.html> .
- Shapiro, S.L. and Teukolsky, S.A. 1983. *Black Holes, White Dwarfs and Neutron Stars*, New York: Wiley.
- Tritton, D. J. 1977. *Physical Fluid Dynamics*, Wokingham: van Nostrand-Reinhold.
- University of Iowa Fluids Laboratory. 1999. *Flow Visualization & Simulation Gallery*, <http://css.engineering.uiowa.edu/fluidslab/referenc/visualizations.html> .
- White, F. M. 1974. *Viscous Fluid Flow*, New York: McGraw-Hill.

Box 13.5

Terminology in Chapter 13

This chapter introduces a large amount of terminology. We list much of it here.

adiabatic A process in which each fluid element conserves its entropy.

adiabatic index The parameter Γ that relates pressure and density changes $\delta P/P = \Gamma \delta \rho/\rho$ in an adiabatic process. For an ideal gas, it is the ratio of specific heats, $\Gamma = \gamma \equiv C_P/C_V$.

advective time derivative The time derivative $d/dt = \partial/\partial t + \mathbf{v} \cdot \nabla$ moving with the fluid. Also called the convective time derivative.

barotropic A process or equation in which pressure can be regarded as a function solely of density, $P = P(\rho)$.

Bernoulli function, also sometimes called Bernoulli constant. $B = \rho(\frac{1}{2}v^2 + h + \Phi)$.

bulk viscosity, coefficient of The proportionality constant ζ relating rate of expansion to viscous stress, $\mathbf{T}_{\text{vis}} = -\zeta \theta \mathbf{g}$.

convective time derivative Same as advective time derivative.

dissipation A process that increases the entropy. Viscosity and diffusive heat flow (heat conduction) are forms of dissipation.

equation of state In this chapter, where chemical and nuclear reactions do not occur: relations of the form $u(\rho, s)$, $P(\rho, s)$ or $u(\rho, T)$, $P(\rho, T)$.

Eulerian changes Changes in a quantity at fixed location in space; cf. Lagrangian changes.

Euler equation Newton's " $F = ma$ " equation for an ideal fluid, $\rho d\mathbf{v}/dt = -\nabla P + \rho \mathbf{g}$.

expansion, rate of Fractional rate of increase of a fluid element's volume, $\theta = \nabla \cdot \mathbf{v}$.

gas A fluid in which the separations between molecules are large compared to the molecular sizes and there are no long-range forces between molecules except gravity; contrast this with a liquid.

ideal gas (also called "perfect gas") A gas in which the sizes of the molecules and (nongravitational) forces between them are completely neglected, so the pressure is due solely to kinetic motions of molecules, $P = nk_B T = (\rho/\mu m_p)k_B T$.

ideal flow A flow in which there is no dissipation.

ideal fluid (also called "perfect fluid") A fluid in which there are no dissipative processes.

incompressible A process or fluid in which the fractional changes of density are small, $\delta \rho/\rho \ll 1$, so the velocity can be approximated as divergence free, $\nabla \cdot \mathbf{v} = 0$.

inviscid With negligible viscosity.

irrotational A flow or fluid with vanishing vorticity.

isentropic A process or fluid in which the entropy per unit rest mass s is the same everywhere.

Box 13.5, Continued

isothermal A process or fluid in which the temperature is the same everywhere.

isobar A surface of constant pressure.

kinematic viscosity $\nu \equiv \eta/\rho$, the ratio of the coefficient of shear viscosity to the density.

Lagrangian changes Changes measured moving with the fluid; cf. Eulerian changes.

laminar flow A non-turbulent flow.

liquid A fluid such as water in which the molecules are packed side by side; contrast this with a gas.

mean molecular weight μ The average mass of a molecule in a gas, divided by the mass of a proton.

Navier-Stokes equation Newton's " $F = ma$ " equation for a viscous, incompressible fluid, $d\mathbf{v}/dt = -(1/\rho)\nabla P + \nu\nabla^2\mathbf{v} + \mathbf{g}$.

Newtonian fluid Two meanings: (i) nonrelativistic fluid; (ii) a fluid in which the shear stress tensor is proportional to the rate of shear σ and is time-independent when σ is constant.

perfect gas Ideal gas.

perfect fluid Ideal fluid.

polytropic A barotropic pressure-density relation of the form $P \propto \rho^{1+1/n}$ for some constant n called the *polytropic index*. The proportionality constant is often a function of entropy.

Reynolds' number The ratio $Re = LV/\nu$, where L is the characteristic lengthscale of a flow, V is the characteristic velocity, and ν is the kinematic viscosity. In order of magnitude this is the ratio of inertial acceleration $(\mathbf{v} \cdot \nabla)\mathbf{v}$ to viscous acceleration $\nu\nabla^2\mathbf{v}$ in the Navier-Stokes equation.

rotation, rate of Antisymmetric part of the gradient of velocity; vorticity converted into an antisymmetric tensor using the Levi-Civita tensor.

shear, rate of Symmetric, trace-free part of the gradient of velocity, σ .

steady flow One that is independent of time in some chosen reference frame.

turbulent flow A flow characterized by chaotic fluid motions.

vorticity The curl of the velocity field, ω .

Box 13.6
Important Concepts in Chapter 13

- Dependence of pressure on density: equation of state; $\delta P = K\delta\rho/\rho$ for liquid; $\delta P/P = \Gamma\delta\rho/\rho$ for gas, Sec. 13.2
- Hydrostatic equilibrium, Sec. 13.3
- Archimedes law, Sec. 13.3.1
- Shapes of rotating bodies, Sec. 13.3.2
- Centrifugal potential and hydrostatics in rotating reference frame, Sec. 13.3.3
- Dimensionless variables and their use to explore scalings of physical quantities, Ex. 13.4
- Conservation laws: mass, momentum and energy; Lagrangian vs. Eulerian approach, Sec. 13.4
- Gravitational field: densities and fluxes of momentum and energy, Box 13.4
- Viscous stress and energy flux, Sec. 13.7.2
- Thermal conductivity and diffusive energy flux, Sec. 13.7.2
- Densities and fluxes of mass, momentum, and energy summarized, Tables 13.1 and 13.3
- Euler equation (momentum conservation) for an ideal fluid, Secs. 13.5.2, 13.5.3
- Bernoulli's theorem, Newtonian — Sec. 13.5.4, relativistic — Sec. 13.8.2
- Incompressibility of subsonic gas, Sec. 13.6
- Rates of expansion, rotation, and shear, and vorticity, Secs. 13.5.4 and 13.7.1
- Navier-Stokes equation (momentum conservation) for viscous, incompressible fluid, Sec. 13.7.2
- Energy conservation equivalent to a law for evolution for entropy, Secs. 13.5.5, 13.7.3
- Entropy increase (dissipation) due to viscosity and diffusive heat flow, Sec. 13.7.3
- Molecular origin of viscosity, Sec. 13.7.4